

0.80mm(0.032") Pitch  
Female Header Connector

0508013  
Vertical, SMT

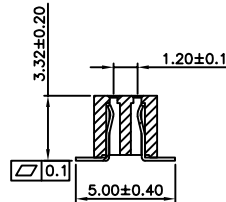
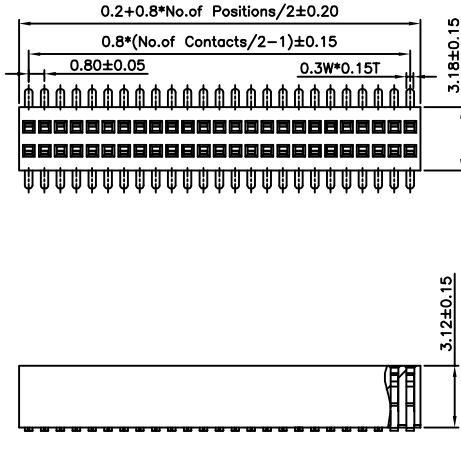
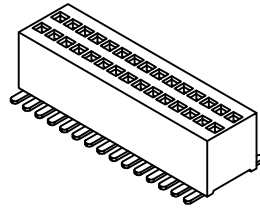

Specifications

Rating

Current Rating:0.8 Amp  
Voltage Rating:100V AC/DC  
Operating Temperature Range:-40~+105°C

Electrical

Contact resistance:20m Ohm Max  
Insulator resistance:500M ohm min.  
Withstanding Voltage:500V AC/Minute

Material And Finish

Insulator:Nylon 6T UL94V-0 Color:Black  
Contact:Phosphor Bronze  
Plated:Gold Flash Over Nickel

No. of CKTS	Part No.	No. of CKTS	Part No.
04	0508013-040101	42	0508013-420101
06	0508013-060101	44	0508013-440101
08	0508013-080101	46	0508013-460101
10	0508013-100101	48	0508013-480101
12	0508013-120101	50	0508013-500101
14	0508013-140101	52	0508013-520101
16	0508013-160101	54	0508013-540101
18	0508013-180101	56	0508013-560101
20	0508013-200101	58	0508013-580101
22	0508013-220101	60	0508013-600101
24	0508013-240101	62	0508013-620101
26	0508013-260101	64	0508013-640101
28	0508013-280101	66	0508013-660101
30	0508013-300101	68	0508013-680101
32	0508013-320101	70	0508013-700101
34	0508013-340101	72	0508013-720101
36	0508013-360101	74	0508013-740101
38	0508013-380101	76	0508013-760101
40	0508013-400101	78	0508013-780101
		80	0508013-800101

1.00mm(0.039") Pitch  
Female Header Connector

0510016  
Vertical, SMT

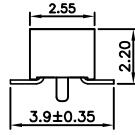
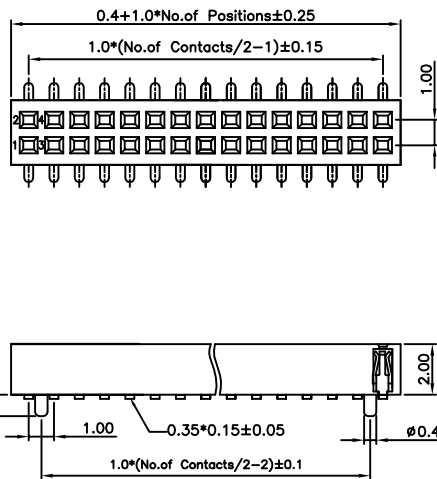

Specifications

Rating

Current Rating:0.8 Amp  
Voltage Rating:100V AC/DC  
Operating Temperature Range:-40~+105°C

Electrical

Contact resistance:20m Ohm Max  
Insulator resistance:500M ohm min.  
Withstanding Voltage:500V AC/Minute

Material And Finish

Insulator:Nylon 6T UL94V-0 Color:Black  
Contact:Phosphor Bronze  
Plated:Gold Flash Over Nickel

No. of CKTS	Part No.	No. of CKTS	Part No.
04	0510016-040101	42	0510016-420101
06	0510016-060101	44	0510016-440101
08	0510016-080101	46	0510016-460101
10	0510016-100101	48	0510016-480101
12	0510016-120101	50	0510016-500101
14	0510016-140101	52	0510016-520101
16	0510016-160101	54	0510016-540101
18	0510016-180101	56	0510016-560101
20	0510016-200101	58	0510016-580101
22	0510016-220101	60	0510016-600101
24	0510016-240101	62	0510016-620101
26	0510016-260101	64	0510016-640101
28	0510016-280101	66	0510016-660101
30	0510016-300101	68	0510016-680101
32	0510016-320101	70	0510016-700101
34	0510016-340101	72	0510016-720101
36	0510016-360101	74	0510016-740101
38	0510016-380101	76	0510016-760101
40	0510016-400101	78	0510016-780101
		80	0510016-800101

1.00mm(0.039") Pitch  
Female Header Connector

0510026  
Vertical, SMT

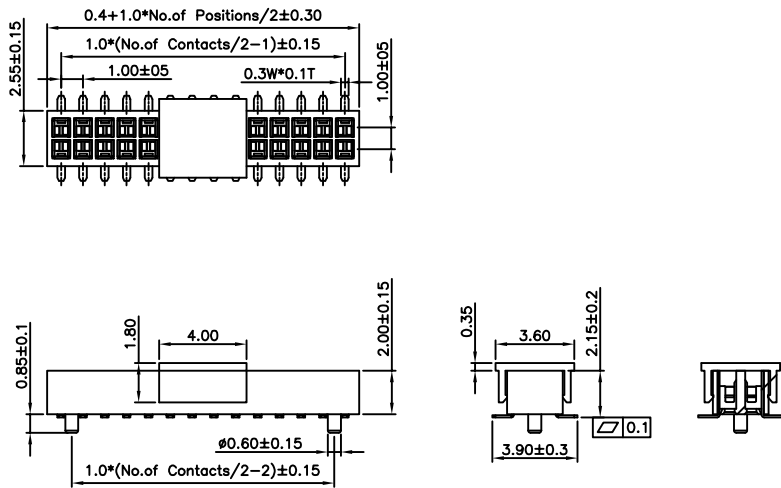

Specifications

Rating

Current Rating:0.8 Amp  
Voltage Rating:100V AC/DC  
Operating Temperature Range:-40~+105°C

Electrical

Contact resistance:20m Ohm Max  
Insulator resistance:500M ohm min.  
Withstanding Voltage:500V AC/Minute

Material And Finish

Insulator:Nylon 6T UL94V-0 Color:Black  
Contact:Phosphor Bronze  
Plated:Gold Flash Over Nickel

No.of CKTS	Part No.	No.of CKTS	Part No.
04	0510026-040104	42	0510026-420104
06	0510026-060104	44	0510026-440104
08	0510026-080104	46	0510026-460104
10	0510026-100104	48	0510026-480104
12	0510026-120104	50	0510026-500104
14	0510026-140104	52	0510026-520104
16	0510026-160104	54	0510026-540104
18	0510026-180104	56	0510026-560104
20	0510026-200104	58	0510026-580104
22	0510026-220104	60	0510026-600104
24	0510026-240104	62	0510026-620104
26	0510026-260104	64	0510026-640104
28	0510026-280104	66	0510026-660104
30	0510026-300104	68	0510026-680104
32	0510026-320104	70	0510026-700104
34	0510026-340104	72	0510026-720104
36	0510026-360104	74	0510026-740104
38	0510026-380104	76	0510026-760104
40	0510026-400104	78	0510026-780104
		80	0510026-800104

1.27mm(0.05") Pitch  
Female Header Connector

0513011  
Vertical, Through Hole

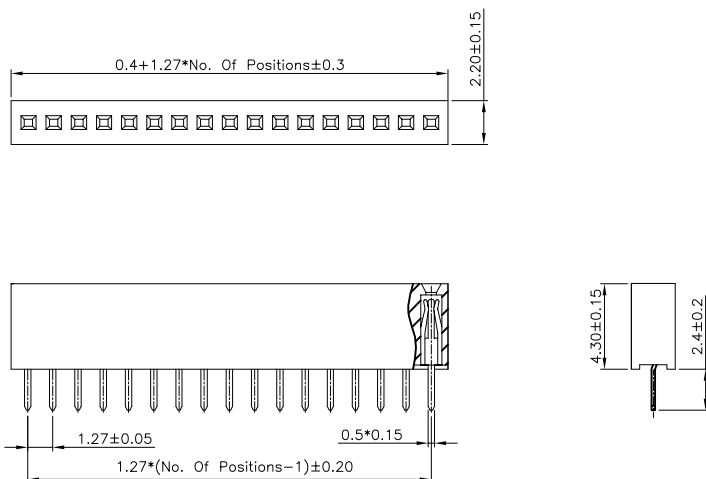

Specifications

Rating

Current Rating:1.0 Amp  
Voltage Rating:100V AC/DC  
Operating Temperature Range:-40~+105°C

Electrical

Contact resistance:20m Ohm Max  
Insulator resistance:500M ohm min.  
Withstanding Voltage:500V AC/Minute

Material And Finish

Insulator:Nylon 6T UL94V-0 Color:Black  
Contact:Phosphor Bronze  
Plated:Gold Flash Over Nickel

No.of CKTS	Part No.	No.of CKTS	Part No.
01	0513011-010101	26	0513011-260101
02	0513011-020101	27	0513011-270101
03	0513011-030101	28	0513011-280101
04	0513011-040101	29	0513011-290101
05	0513011-050101	30	0513011-300101
06	0513011-060101	31	0513011-310101
07	0513011-070101	32	0513011-320101
08	0513011-080101	33	0513011-330101
09	0513011-090101	34	0513011-340101
10	0513011-100101	35	0513011-350101
11	0513011-110101	36	0513011-360101
12	0513011-120101	37	0513011-370101
13	0513011-130101	38	0513011-380101
14	0513011-140101	39	0513011-390101
15	0513011-150101	40	0513011-400101
16	0513011-160101	41	0513011-410101
17	0513011-170101	42	0513011-420101
18	0513011-180101	43	0513011-430101
19	0513011-190101	44	0513011-440101
20	0513011-200101	45	0513011-450101
21	0513011-210101	46	0513011-460101
22	0513011-220101	47	0513011-470101
23	0513011-230101	48	0513011-480101
24	0513011-240101	49	0513011-490101
25	0513011-250101	50	0513011-500101

1.27mm(0.05") Pitch  
Female Header Connector

0513012  
Right Angle, Through Hole

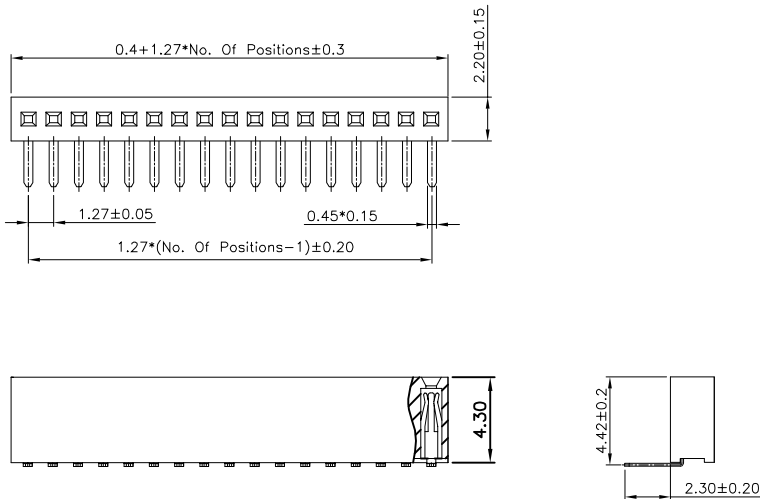

Specifications

Rating

Current Rating:1.0 Amp  
Voltage Rating:100V AC/DC  
Operating Temperature Range:-40~+105°C

Electrical

Contact resistance:20m Ohm Max  
Insulator resistance:500M ohm min.  
Withstanding Voltage:500V AC/Minute

Material And Finish

Insulator:Nylon 6T UL94V-0 Color:Black  
Contact:Phosphor Bronze  
Plated:Gold Flash Over Nickel

No.of CKTS	Part No.	No.of CKTS	Part No.
01	0513012-010101	26	0513012-260101
02	0513012-020101	27	0513012-270101
03	0513012-030101	28	0513012-280101
04	0513012-040101	29	0513012-290101
05	0513012-050101	30	0513012-300101
06	0513012-060101	31	0513012-310101
07	0513012-070101	32	0513012-320101
08	0513012-080101	33	0513012-330101
09	0513012-090101	34	0513012-340101
10	0513012-100101	35	0513012-350101
11	0513012-110101	36	0513012-360101
12	0513012-120101	37	0513012-370101
13	0513012-130101	38	0513012-380101
14	0513012-140101	39	0513012-390101
15	0513012-150101	40	0513012-400101
16	0513012-160101	41	0513012-410101
17	0513012-170101	42	0513012-420101
18	0513012-180101	43	0513012-430101
19	0513012-190101	44	0513012-440101
20	0513012-200101	45	0513012-450101
21	0513012-210101	46	0513012-460101
22	0513012-220101	47	0513012-470101
23	0513012-230101	48	0513012-480101
24	0513012-240101	49	0513012-490101
25	0513012-250101	50	0513012-500101

1.27mm(0.05") Pitch  
Female Header Connector

0513014  
Right Angle, SMT

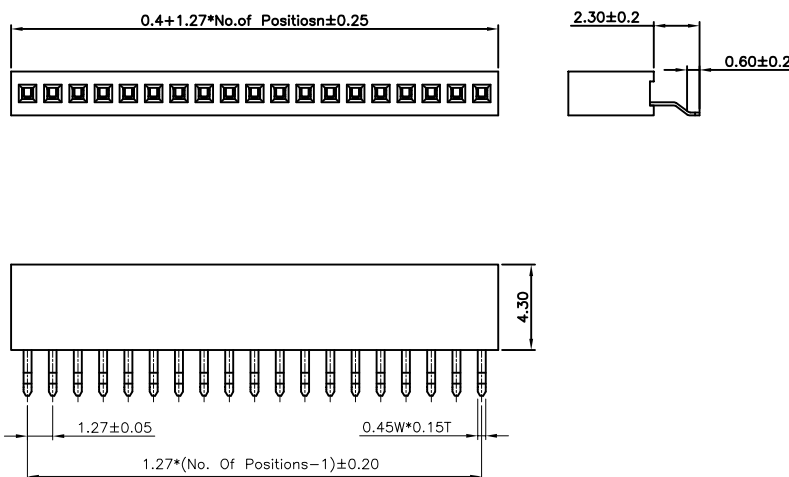

Specifications

Rating

Current Rating:1.0 Amp  
Voltage Rating:100V AC/DC  
Operating Temperature Range:-40~+105°C

Electrical

Contact resistance:20m Ohm Max  
Insulator resistance:500M ohm min.  
Withstanding Voltage:500V AC/Minute

Material And Finish

Insulator:Nylon 6T UL94V-0 Color:Black  
Contact:Phosphor Bronze  
Plated:Gold Flash Over Nickel

No.of CKTS	Part No.	No.of CKTS	Part No.
01	0513014-010101	26	0513014-260101
02	0513014-020101	27	0513014-270101
03	0513014-030101	28	0513014-280101
04	0513014-040101	29	0513014-290101
05	0513014-050101	30	0513014-300101
06	0513014-060101	31	0513014-310101
07	0513014-070101	32	0513014-320101
08	0513014-080101	33	0513014-330101
09	0513014-090101	34	0513014-340101
10	0513014-100101	35	0513014-350101
11	0513014-110101	36	0513014-360101
12	0513014-120101	37	0513014-370101
13	0513014-130101	38	0513014-380101
14	0513014-140101	39	0513014-390101
15	0513014-150101	40	0513014-400101
16	0513014-160101	41	0513014-410101
17	0513014-170101	42	0513014-420101
18	0513014-180101	43	0513014-430101
19	0513014-190101	44	0513014-440101
20	0513014-200101	45	0513014-450101
21	0513014-210101	46	0513014-460101
22	0513014-220101	47	0513014-470101
23	0513014-230101	48	0513014-480101
24	0513014-240101	49	0513014-490101
25	0513014-250101	50	0513014-500101

1.27mm(0.05") Pitch  
Female Header Connector

0513018  
Vertical, SMT

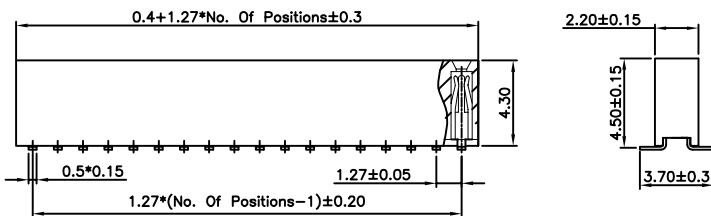
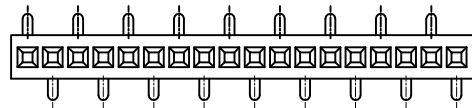

Specifications

Rating

Current Rating:1.0 Amp  
Voltage Rating:100V AC/DC  
Operating Temperature Range:-40°~+105°C

Electrical

Contact resistance:20m Ohm Max  
Insulator resistance:500M ohm min.  
Withstanding Voltage:500V AC/Minute

Material And Finish

Insulator:Nylon 6T UL94V-0 Color:Black  
Contact:Phosphor Bronze  
Plated:Gold Flash Over Nickel

No.of CKTS	Part No.	No.of CKTS	Part No.
		26	0513018-260101
02	0513018-020101	27	0513018-270101
03	0513018-030101	28	0513018-280101
04	0513018-040101	29	0513018-290101
05	0513018-050101	30	0513018-300101
06	0513018-060101	31	0513018-310101
07	0513018-070101	32	0513018-320101
08	0513018-080101	33	0513018-330101
09	0513018-090101	34	0513018-340101
10	0513018-100101	35	0513018-350101
11	0513018-110101	36	0513018-360101
12	0513018-120101	37	0513018-370101
13	0513018-130101	38	0513018-380101
14	0513018-140101	39	0513018-390101
15	0513018-150101	40	0513018-400101
16	0513018-160101	41	0513018-410101
17	0513018-170101	42	0513018-420101
18	0513018-180101	43	0513018-430101
19	0513018-190101	44	0513018-440101
20	0513018-200101	45	0513018-450101
21	0513018-210101	46	0513018-460101
22	0513018-220101	47	0513018-470101
23	0513018-230101	48	0513018-480101
24	0513018-240101	49	0513018-490101
25	0513018-250101	50	0513018-500101

1.27mm(0.05") Pitch  
Female Header Connector

0513023  
Vertical, SMT

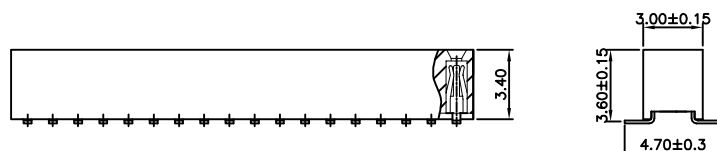
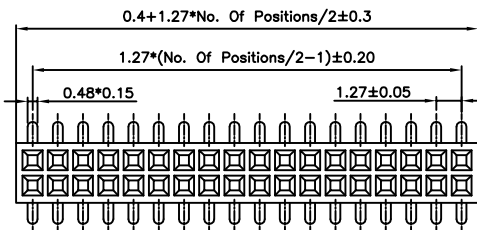

Specifications

Rating

Current Rating:1.0 Amp  
Voltage Rating:100V AC/DC  
Operating Temperature Range:-40°~+105°C

Electrical

Contact resistance:20m Ohm Max  
Insulator resistance:500M ohm min.  
Withstanding Voltage:500V AC/Minute

Material And Finish

Insulator:Nylon 6T UL94V-0 Color:Black  
Contact:Phosphor Bronze  
Plated:Gold Flash Over Nickel

No.of CKTS	Part No.	No.of CKTS	Part No.
		52	0513023-520101
04	0513023-040101	54	0513023-540101
06	0513023-060101	56	0513023-560101
08	0513023-080101	58	0513023-580101
10	0513023-100101	60	0513023-600101
12	0513023-120101	62	0513023-620101
14	0513023-140101	64	0513023-640101
16	0513023-160101	66	0513023-660101
18	0513023-180101	68	0513023-680101
20	0513023-200101	70	0513023-700101
22	0513023-220101	72	0513023-720101
24	0513023-240101	74	0513023-740101
26	0513023-260101	76	0513023-760101
28	0513023-280101	78	0513023-780101
30	0513023-300101	80	0513023-800101
32	0513023-320101	82	0513023-820101
34	0513023-340101	84	0513023-840101
36	0513023-360101	86	0513023-860101
38	0513023-380101	88	0513023-880101
40	0513023-400101	90	0513023-900101
42	0513023-420101	92	0513023-920101
44	0513023-440101	94	0513023-940101
46	0513023-460101	96	0513023-960101
48	0513023-480101	98	0513023-980101
50	0513023-500101	100	0513023-1000101

1.27mm(0.05") Pitch  
Female Header Connector

0513031  
Vertical, Through Hole

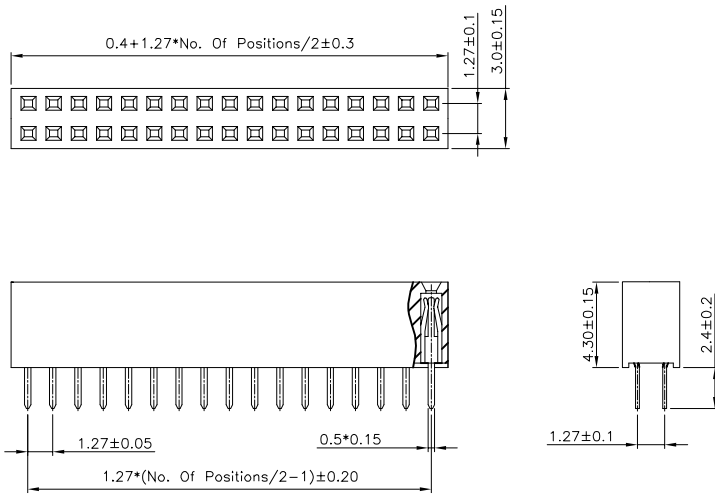

Specifications

Rating

Current Rating:1.0 Amp  
Voltage Rating:100V AC/DC  
Operating Temperature Range:-40°~+105°C

Electrical

Contact resistance:20m Ohm Max  
Insulator resistance:500M ohm min.  
Withstanding Voltage:500V AC/Minute

Material And Finish

Insulator:Nylon 6T UL94V-0 Color:Black  
Contact:Phosphor Bronze  
Plated:Gold Flash Over Nickel

No.of CKTS	Part No.	No.of CKTS	Part No.
		52	0513031-520101
04	0513031-040101	54	0513031-540101
06	0513031-060101	56	0513031-560101
08	0513031-080101	58	0513031-580101
10	0513031-100101	60	0513031-600101
12	0513031-120101	62	0513031-620101
14	0513031-140101	64	0513031-640101
16	0513031-160101	66	0513031-660101
18	0513031-180101	68	0513031-680101
20	0513031-200101	70	0513031-700101
22	0513031-220101	72	0513031-720101
24	0513031-240101	74	0513031-740101
26	0513031-260101	76	0513031-760101
28	0513031-280101	78	0513031-780101
30	0513031-300101	80	0513031-800101
32	0513031-320101	82	0513031-820101
34	0513031-340101	84	0513031-840101
36	0513031-360101	86	0513031-860101
38	0513031-380101	88	0513031-880101
40	0513031-400101	90	0513031-900101
42	0513031-420101	92	0513031-920101
44	0513031-440101	94	0513031-940101
46	0513031-460101	96	0513031-960101
48	0513031-480101	98	0513031-980101
50	0513031-500101	100	0513031-1000101

1.27mm(0.05") Pitch  
Female Header Connector

0513032  
Right Angle, Through Hole

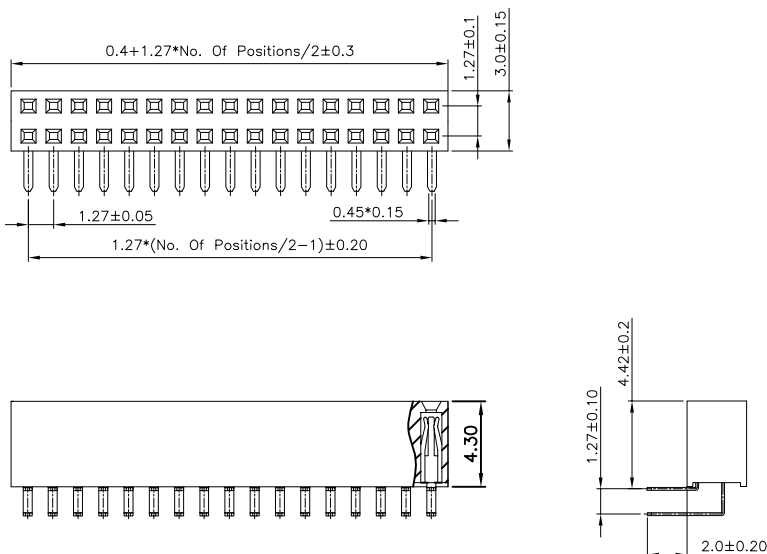

Specifications

Rating

Current Rating:1.0 Amp  
Voltage Rating:100V AC/DC  
Operating Temperature Range:-40°~+105°C

Electrical

Contact resistance:20m Ohm Max  
Insulator resistance:500M ohm min.  
Withstanding Voltage:500V AC/Minute

Material And Finish

Insulator:Nylon 6T UL94V-0 Color:Black  
Contact:Phosphor Bronze  
Plated:Gold Flash Over Nickel

No.of CKTS	Part No.	No.of CKTS	Part No.
		52	0513032-520101
04	0513032-040101	54	0513032-540101
06	0513032-060101	56	0513032-560101
08	0513032-080101	58	0513032-580101
10	0513032-100101	60	0513032-600101
12	0513032-120101	62	0513032-620101
14	0513032-140101	64	0513032-640101
16	0513032-160101	66	0513032-660101
18	0513032-180101	68	0513032-680101
20	0513032-200101	70	0513032-700101
22	0513032-220101	72	0513032-720101
24	0513032-240101	74	0513032-740101
26	0513032-260101	76	0513032-760101
28	0513032-280101	78	0513032-780101
30	0513032-300101	80	0513032-800101
32	0513032-320101	82	0513032-820101
34	0513032-340101	84	0513032-840101
36	0513032-360101	86	0513032-860101
38	0513032-380101	88	0513032-880101
40	0513032-400101	90	0513032-900101
42	0513032-420101	92	0513032-920101
44	0513032-440101	94	0513032-940101
46	0513032-460101	96	0513032-960101
48	0513032-480101	98	0513032-980101
50	0513032-500101	100	0513032-1000101

1.27mm(0.05") Pitch  
Female Header Connector

0513033  
Vertical, SMT

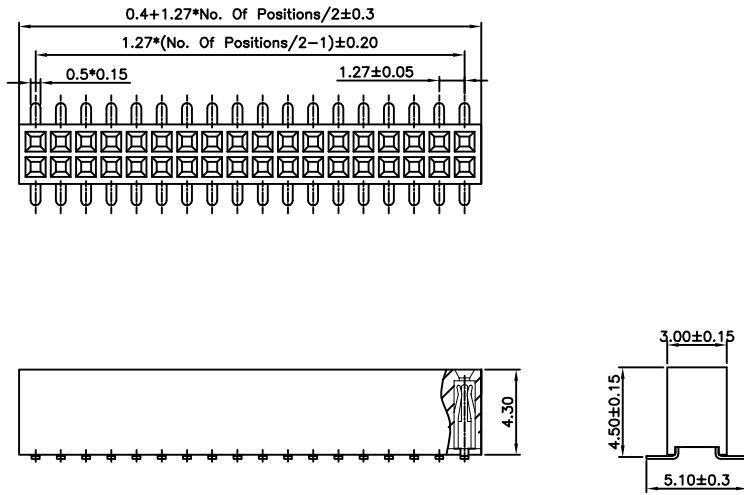

Specifications

Rating

Current Rating:1.0 Amp  
Voltage Rating:100V AC/DC  
Operating Temperature Range:-40°~+105°C

Electrical

Contact resistance:20m Ohm Max  
Insulator resistance:500M ohm min.  
Withstanding Voltage:500V AC/Minute

Material And Finish

Insulator:Nylon 6T UL94V-0 Color:Black  
Contact:Phosphor Bronze  
Plated:Gold Flash Over Nickel

No.of CKTS	Part No.	No.of CKTS	Part No.
		52	0513033-520101
04	0513033-040101	54	0513033-540101
06	0513033-060101	56	0513033-560101
08	0513033-080101	58	0513033-580101
10	0513033-100101	60	0513033-600101
12	0513033-120101	62	0513033-620101
14	0513033-140101	64	0513033-640101
16	0513033-160101	66	0513033-660101
18	0513033-180101	68	0513033-680101
20	0513033-200101	70	0513033-700101
22	0513033-220101	72	0513033-720101
24	0513033-240101	74	0513033-740101
26	0513033-260101	76	0513033-760101
28	0513033-280101	78	0513033-780101
30	0513033-300101	80	0513033-800101
32	0513033-320101	82	0513033-820101
34	0513033-340101	84	0513033-840101
36	0513033-360101	86	0513033-860101
38	0513033-380101	88	0513033-880101
40	0513033-400101	90	0513033-900101
42	0513033-420101	92	0513033-920101
44	0513033-440101	94	0513033-940101
46	0513033-460101	96	0513033-960101
48	0513033-480101	98	0513033-980101
50	0513033-500101	100	0513033-1000101

1.27mm(0.05") Pitch  
Female Header Connector

0513035  
Right Angle, SMT

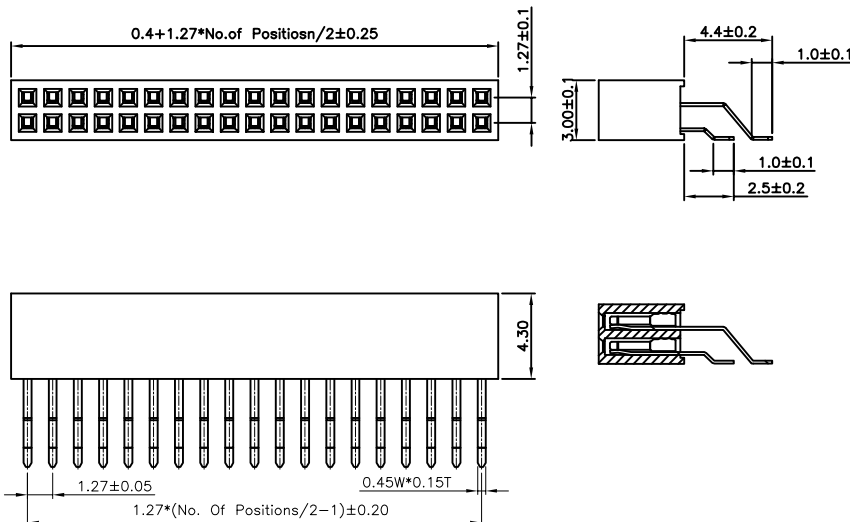

Specifications

Rating

Current Rating:1.0 Amp  
Voltage Rating:100V AC/DC  
Operating Temperature Range:-40°~+105°C

Electrical

Contact resistance:20m Ohm Max  
Insulator resistance:500M ohm min.  
Withstanding Voltage:500V AC/Minute

Material And Finish

Insulator:Nylon 6T UL94V-0 Color:Black  
Contact:Phosphor Bronze  
Plated:Gold Flash Over Nickel

No.of CKTS	Part No.	No.of CKTS	Part No.
		52	0513035-520101
04	0513035-040101	54	0513035-540101
06	0513035-060101	56	0513035-560101
08	0513035-080101	58	0513035-580101
10	0513035-100101	60	0513035-600101
12	0513035-120101	62	0513035-620101
14	0513035-140101	64	0513035-640101
16	0513035-160101	66	0513035-660101
18	0513035-180101	68	0513035-680101
20	0513035-200101	70	0513035-700101
22	0513035-220101	72	0513035-720101
24	0513035-240101	74	0513035-740101
26	0513035-260101	76	0513035-760101
28	0513035-280101	78	0513035-780101
30	0513035-300101	80	0513035-800101
32	0513035-320101	82	0513035-820101
34	0513035-340101	84	0513035-840101
36	0513035-360101	86	0513035-860101
38	0513035-380101	88	0513035-880101
40	0513035-400101	90	0513035-900101
42	0513035-420101	92	0513035-920101
44	0513035-440101	94	0513035-940101
46	0513035-460101	96	0513035-960101
48	0513035-480101	98	0513035-980101
50	0513035-500101	100	0513035-1000101

1.27mm(0.05") Pitch  
Female Header Connector

0513037  
Vertical, SMT

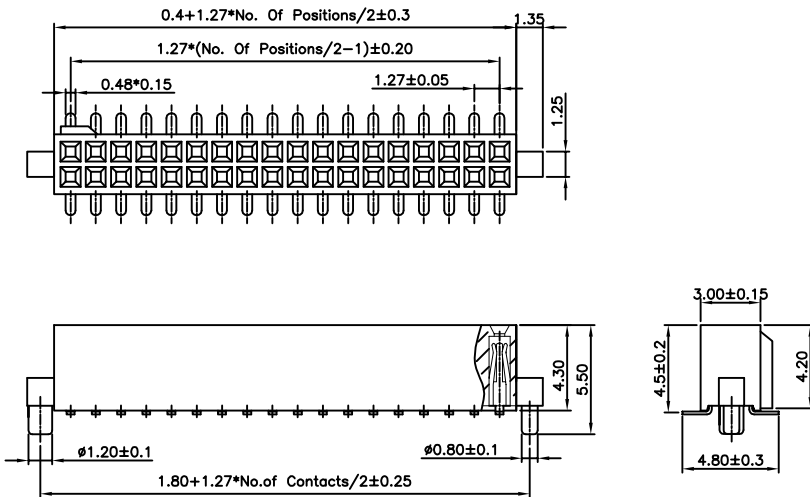

Specifications

Rating

Current Rating:1.0 Amp  
Voltage Rating:100V AC/DC  
Operating Temperature Range:-40°~+105°C

Electrical

Contact resistance:20m Ohm Max  
Insulator resistance:500M ohm min.  
Withstanding Voltage:500V AC/Minute

Material And Finish

Insulator:Nylon 6T UL94V-0 Color:Black  
Contact:Phosphor Bronze  
Plated:Gold Flash Over Nickel

No.of CKTS	Part No.	No.of CKTS	Part No.
		52	0513037-520101
		54	0513037-540101
06	0513037-060101	56	0513037-560101
08	0513037-080101	58	0513037-580101
10	0513037-100101	60	0513037-600101
12	0513037-120101	62	0513037-620101
14	0513037-140101	64	0513037-640101
16	0513037-160101	66	0513037-660101
18	0513037-180101	68	0513037-680101
20	0513037-200101	70	0513037-700101
22	0513037-220101	72	0513037-720101
24	0513037-240101	74	0513037-740101
26	0513037-260101	76	0513037-760101
28	0513037-280101	78	0513037-780101
30	0513037-300101	80	0513037-800101
32	0513037-320101	82	0513037-820101
34	0513037-340101	84	0513037-840101
36	0513037-360101	86	0513037-860101
38	0513037-380101	88	0513037-880101
40	0513037-400101	90	0513037-900101
42	0513037-420101	92	0513037-920101
44	0513037-440101	94	0513037-940101
46	0513037-460101	96	0513037-960101
48	0513037-480101	98	0513037-980101
50	0513037-500101	100	0513037-1000101

1.27mm(0.05") Pitch  
Female Header Connector

0513051  
Vertical, Through Hole

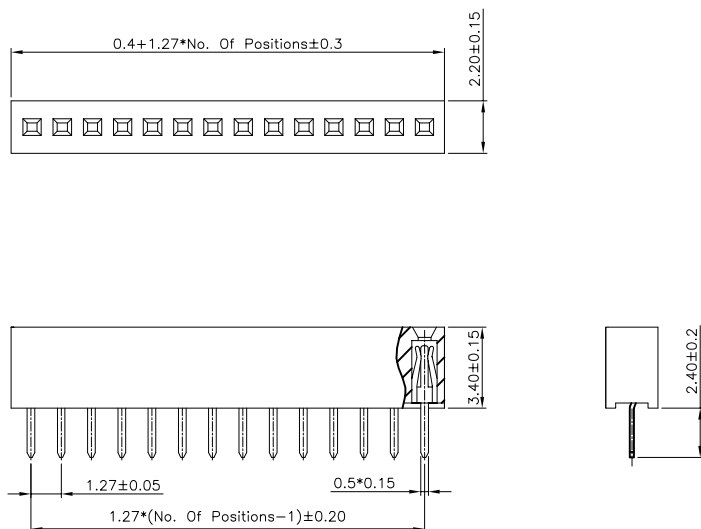

Specifications

Rating

Current Rating:1.0 Amp  
Voltage Rating:100V AC/DC  
Operating Temperature Range:-40°~+105°C

Electrical

Contact resistance:20m Ohm Max  
Insulator resistance:500M ohm min.  
Withstanding Voltage:500V AC/Minute

Material And Finish

Insulator:Nylon 6T UL94V-0 Color:Black  
Contact:Phosphor Bronze  
Plated:Gold Flash Over Nickel

No.of CKTS	Part No.	No.of CKTS	Part No.
		21	0513051-210101
02	0513051-020101	22	0513051-220101
03	0513051-030101	23	0513051-230101
04	0513051-040101	24	0513051-240101
05	0513051-050101	25	0513051-250101
06	0513051-060101	26	0513051-260101
07	0513051-070101	27	0513051-270101
08	0513051-080101	28	0513051-280101
09	0513051-090101	29	0513051-290101
10	0513051-100101	30	0513051-300101
11	0513051-110101	31	0513051-310101
12	0513051-120101	32	0513051-320101
13	0513051-130101	33	0513051-330101
14	0513051-140101	34	0513051-340101
15	0513051-150101	35	0513051-350101
16	0513051-160101	36	0513051-360101
17	0513051-170101	37	0513051-370101
18	0513051-180101	38	0513051-380101
19	0513051-190101	39	0513051-390101
20	0513051-200101	40	0513051-400101

1.27mm(0.05") Pitch  
Female Header Connector

0513058  
Vertical, SMT

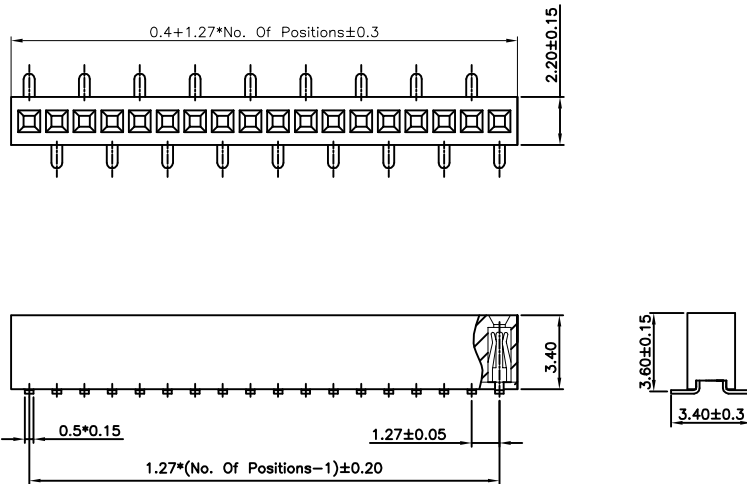

**Specifications**

**Rating**

Current Rating:1.0 Amp  
Voltage Rating:100V AC/DC  
Operating Temperature Range:-40°~+105°C

**Electrical**

Contact resistance:20m Ohm Max  
Insulator resistance:500M ohm min.  
Withstanding Voltage:500V AC/Minute

**Material And Finish**

Insulator:Nylon 6T UL94V-0 Color:Black  
Contact:Phosphor Bronze  
Plated:Gold Flash Over Nickel

No.of CKTS	Part No.	No.of CKTS	Part No.
		21	0513058-210101
02	0513058-020101	22	0513058-220101
03	0513058-030101	23	0513058-230101
04	0513058-040101	24	0513058-240101
05	0513058-050101	25	0513058-250101
06	0513058-060101	26	0513058-260101
07	0513058-070101	27	0513058-270101
08	0513058-080101	28	0513058-280101
09	0513058-090101	29	0513058-290101
10	0513058-100101	30	0513058-300101
11	0513058-110101	31	0513058-310101
12	0513058-120101	32	0513058-320101
13	0513058-130101	33	0513058-330101
14	0513058-140101	34	0513058-340101
15	0513058-150101	35	0513058-350101
16	0513058-160101	36	0513058-360101
17	0513058-170101	37	0513058-370101
18	0513058-180101	38	0513058-380101
19	0513058-190101	39	0513058-390101
20	0513058-200101	40	0513058-400101

1.27mm(0.05") Pitch  
Female Header Connector

0513059  
Vertical, SMT

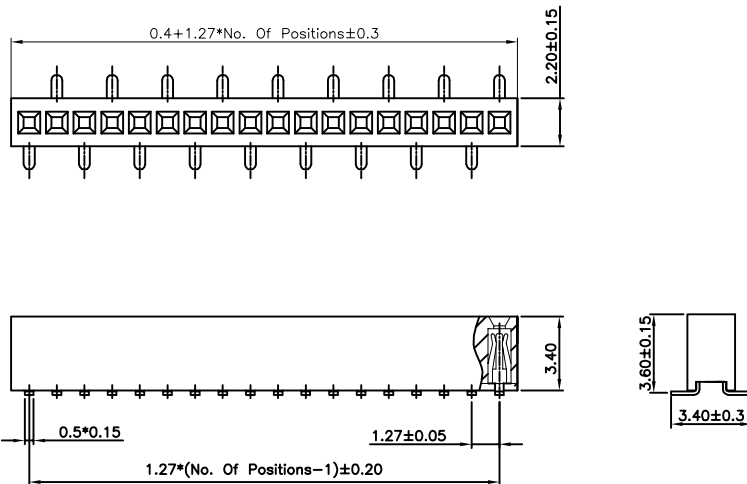

**Specifications**

**Rating**

Current Rating:1.0 Amp  
Voltage Rating:100V AC/DC  
Operating Temperature Range:-40°~+105°C

**Electrical**

Contact resistance:20m Ohm Max  
Insulator resistance:500M ohm min.  
Withstanding Voltage:500V AC/Minute

**Material And Finish**

Insulator:Nylon 6T UL94V-0 Color:Black  
Contact:Phosphor Bronze  
Plated:Gold Flash Over Nickel

No.of CKTS	Part No.	No.of CKTS	Part No.
		21	0513059-210101
02	0513059-020101	22	0513059-220101
03	0513059-030101	23	0513059-230101
04	0513059-040101	24	0513059-240101
05	0513059-050101	25	0513059-250101
06	0513059-060101	26	0513059-260101
07	0513059-070101	27	0513059-270101
08	0513059-080101	28	0513059-280101
09	0513059-090101	29	0513059-290101
10	0513059-100101	30	0513059-300101
11	0513059-110101	31	0513059-310101
12	0513059-120101	32	0513059-320101
13	0513059-130101	33	0513059-330101
14	0513059-140101	34	0513059-340101
15	0513059-150101	35	0513059-350101
16	0513059-160101	36	0513059-360101
17	0513059-170101	37	0513059-370101
18	0513059-180101	38	0513059-380101
19	0513059-190101	39	0513059-390101
20	0513059-200101	40	0513059-400101



1.27mm(0.05") Pitch  
Female Header Connector

0513067  
Vertical, SMT

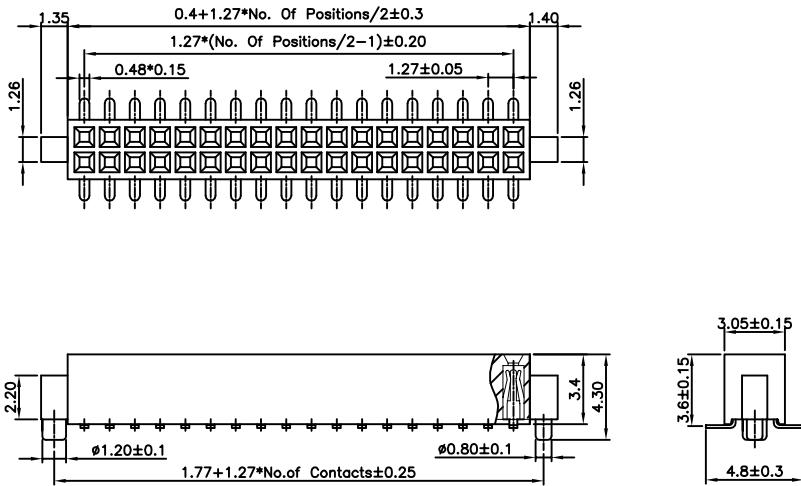

Specifications

Rating

Current Rating:1.0 Amp  
Voltage Rating:100V AC/DC  
Operating Temperature Range:-40~+105°C

Electrical

Contact resistance:20m Ohm Max  
Insulator resistance:500M ohm min.  
Withstanding Voltage:500V AC/Minute

Material And Finish

Insulator:Nylon 6T UL94V-0 Color:Black  
Contact:Phosphor Bronze  
Plated:Gold Flash Over Nickel

No.of CKTS	Part No.	No.of CKTS	Part No.
04	0513067-040101	42	0513067-420101
06	0513067-060101	44	0513067-440101
08	0513067-080101	46	0513067-460101
10	0513067-100101	48	0513067-480101
12	0513067-120101	50	0513067-500101
14	0513067-140101	52	0513067-520101
16	0513067-160101	54	0513067-540101
18	0513067-180101	56	0513067-560101
20	0513067-200101	58	0513067-580101
22	0513067-220101	60	0513067-600101
24	0513067-240101	62	0513067-620101
26	0513067-260101	64	0513067-640101
28	0513067-280101	66	0513067-660101
30	0513067-300101	68	0513067-680101
32	0513067-320101	70	0513067-700101
34	0513067-340101	72	0513067-720101
36	0513067-360101	74	0513067-740101
38	0513067-380101	76	0513067-760101
40	0513067-400101	78	0513067-780101
		80	0513067-800101

1.27mm(0.05") Pitch  
Female Header Connector

0513061  
Vertical, Through Hole

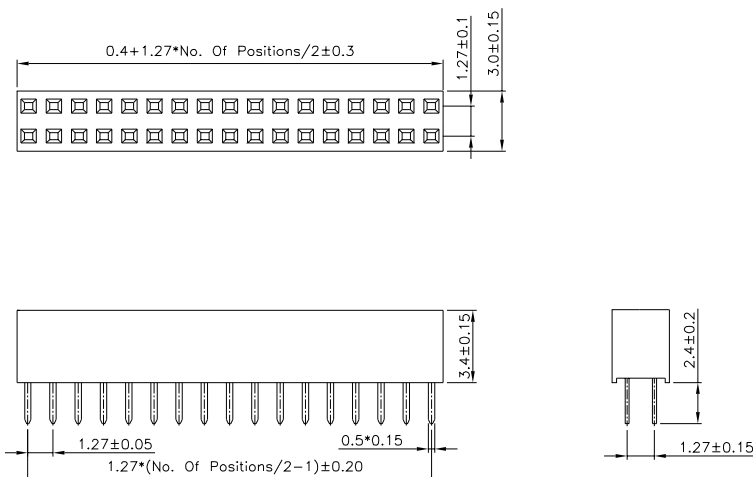

Specifications

Rating

Current Rating:1.0 Amp  
Voltage Rating:100V AC/DC  
Operating Temperature Range:-40~+105°C

Electrical

Contact resistance:20m Ohm Max  
Insulator resistance:500M ohm min.  
Withstanding Voltage:500V AC/Minute

Material And Finish

Insulator:Nylon 6T UL94V-0 Color:Black  
Contact:Phosphor Bronze  
Plated:Gold Flash Over Nickel

No.of CKTS	Part No.	No.of CKTS	Part No.
04	0513061-040101	42	0513061-420101
06	0513061-060101	44	0513061-440101
08	0513061-080101	46	0513061-460101
10	0513061-100101	48	0513061-480101
12	0513061-120101	50	0513061-500101
14	0513061-140101	52	0513061-520101
16	0513061-160101	54	0513061-540101
18	0513061-180101	56	0513061-560101
20	0513061-200101	58	0513061-580101
22	0513061-220101	60	0513061-600101
24	0513061-240101	62	0513061-620101
26	0513061-260101	64	0513061-640101
28	0513061-280101	66	0513061-660101
30	0513061-300101	68	0513061-680101
32	0513061-320101	70	0513061-700101
34	0513061-340101	72	0513061-720101
36	0513061-360101	74	0513061-740101
38	0513061-380101	76	0513061-760101
40	0513061-400101	78	0513061-780101
		80	0513061-800101

1.27mm(0.05") Pitch  
Female Header Connector

0513078  
Vertical, SMT

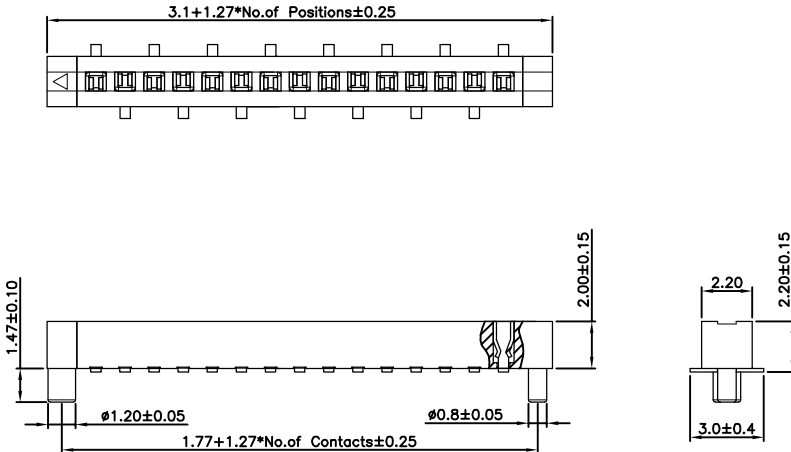

**Specifications**

**Rating**

Current Rating:1.0 Amp  
Voltage Rating:100V AC/DC  
Operating Temperature Range:-40°~+105°C

**Electrical**

Contact resistance:20m Ohm Max  
Insulator resistance:500M ohm min.  
Withstanding Voltage:500V AC/Minute

**Material And Finish**

Insulator:Nylon 6T UL94V-0 Color:Black  
Contact:Phosphor Bronze  
Plated:Gold Flash Over Nickel

No. of CKTS	Part No.	No. of CKTS	Part No.
		21	0513078-210101
		22	0513078-220101
		23	0513078-230101
04	0513078-040101	24	0513078-240101
05	0513078-050101	25	0513078-250101
06	0513078-060101	26	0513078-260101
07	0513078-070101	27	0513078-270101
08	0513078-080101	28	0513078-280101
09	0513078-090101	29	0513078-290101
10	0513078-100101	30	0513078-300101
11	0513078-110101	31	0513078-310101
12	0513078-120101	32	0513078-320101
13	0513078-130101	33	0513078-330101
14	0513078-140101	34	0513078-340101
15	0513078-150101	35	0513078-350101
16	0513078-160101	36	0513078-360101
17	0513078-170101	37	0513078-370101
18	0513078-180101	38	0513078-380101
19	0513078-190101	39	0513078-390101
20	0513078-200101	40	0513078-400101

1.27mm(0.05") Pitch  
Female Header Connector

0513086  
Vertical, SMT

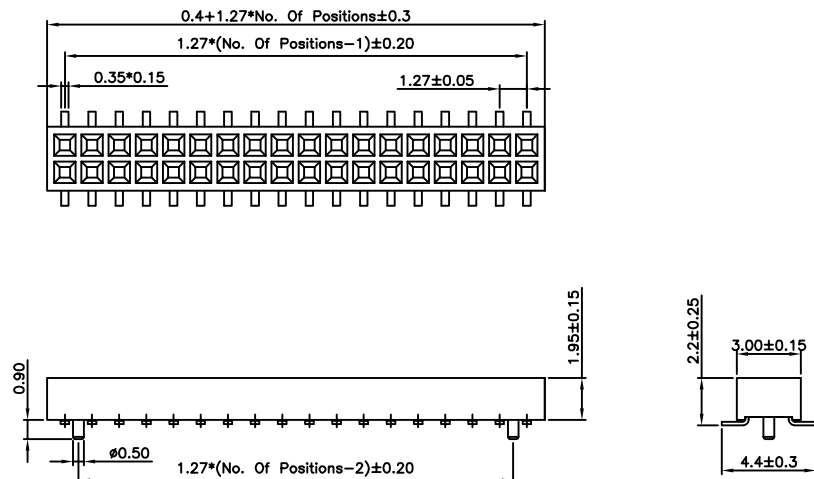

**Specifications**

**Rating**

Current Rating:1.0 Amp  
Voltage Rating:100V AC/DC  
Operating Temperature Range:-40°~+105°C

**Electrical**

Contact resistance:20m Ohm Max  
Insulator resistance:500M ohm min.  
Withstanding Voltage:500V AC/Minute

**Material And Finish**

Insulator:Nylon 6T UL94V-0 Color:Black  
Contact:Phosphor Bronze  
Plated:Gold Flash Over Nickel

No. of CKTS	Part No.	No. of CKTS	Part No.
		42	0513086-420101
04	0513086-040101	44	0513086-440101
06	0513086-060101	46	0513086-460101
08	0513086-080101	48	0513086-480101
10	0513086-100101	50	0513086-500101
12	0513086-120101	52	0513086-520101
14	0513086-140101	54	0513086-540101
16	0513086-160101	56	0513086-560101
18	0513086-180101	58	0513086-580101
20	0513086-200101	60	0513086-600101
22	0513086-220101	62	0513086-620101
24	0513086-240101	64	0513086-640101
26	0513086-260101	66	0513086-660101
28	0513086-280101	68	0513086-680101
30	0513086-300101	70	0513086-700101
32	0513086-320101	72	0513086-720101
34	0513086-340101	74	0513086-740101
36	0513086-360101	76	0513086-760101
38	0513086-380101	78	0513086-780101
40	0513086-400101	80	0513086-800101

1.27mm(0.05") Pitch  
Female Header Connector

0513092  
Right Angle, Through Hole

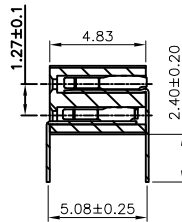
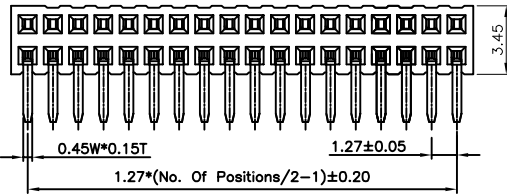
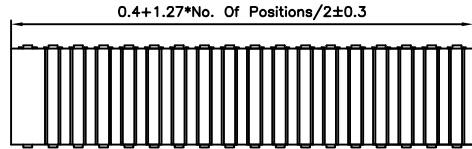
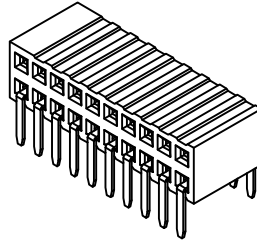

Specifications

Rating

Current Rating:1.0 Amp  
Voltage Rating:100V AC/DC  
Operating Temperature Range:-40°~+105°C

Electrical

Contact resistance:20m Ohm Max  
Insulator resistance:500M ohm min.  
Withstanding Voltage:500V AC/Minute

Material And Finish

Insulator:Nylon 6T UL94V-0 Color:Black  
Contact:Phosphor Bronze  
Plated:Gold Flash Over Nickel

No.of CKTS	Part No.	No.of CKTS	Part No.
		52	0513092-520101
04	0513092-040101	54	0513092-540101
06	0513092-060101	56	0513092-560101
08	0513092-080101	58	0513092-580101
10	0513092-100101	60	0513092-600101
12	0513092-120101	62	0513092-620101
14	0513092-140101	64	0513092-640101
16	0513092-160101	66	0513092-660101
18	0513092-180101	68	0513092-680101
20	0513092-200101	70	0513092-700101
22	0513092-220101	72	0513092-720101
24	0513092-240101	74	0513092-740101
26	0513092-260101	76	0513092-760101
28	0513092-280101	78	0513092-780101
30	0513092-300101	80	0513092-800101
32	0513092-320101	82	0513092-820101
34	0513092-340101	84	0513092-840101
36	0513092-360101	86	0513092-860101
38	0513092-380101	88	0513092-880101
40	0513092-400101	90	0513092-900101
42	0513092-420101	92	0513092-920101
44	0513092-440101	94	0513092-940101
46	0513092-460101	96	0513092-960101
48	0513092-480101	98	0513092-980101
50	0513092-500101	100	0513092-1000101

1.27mm(0.05") Pitch  
Female Header Connector

0513094  
Right Angle, SMT

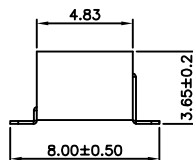
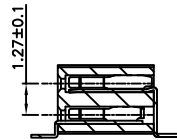
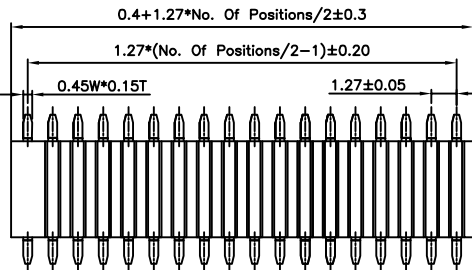

Specifications

Rating

Current Rating:1.0 Amp  
Voltage Rating:100V AC/DC  
Operating Temperature Range:-40°~+105°C

Electrical

Contact resistance:20m Ohm Max  
Insulator resistance:500M ohm min.  
Withstanding Voltage:500V AC/Minute

Material And Finish

Insulator:Nylon 6T UL94V-0 Color:Black  
Contact:Phosphor Bronze  
Plated:Gold Flash Over Nickel

No.of CKTS	Part No.	No.of CKTS	Part No.
		52	0513094-520101
04	0513094-040101	54	0513094-540101
06	0513094-060101	56	0513094-560101
08	0513094-080101	58	0513094-580101
10	0513094-100101	60	0513094-600101
12	0513094-120101	62	0513094-620101
14	0513094-140101	64	0513094-640101
16	0513094-160101	66	0513094-660101
18	0513094-180101	68	0513094-680101
20	0513094-200101	70	0513094-700101
22	0513094-220101	72	0513094-720101
24	0513094-240101	74	0513094-740101
26	0513094-260101	76	0513094-760101
28	0513094-280101	78	0513094-780101
30	0513094-300101	80	0513094-800101
32	0513094-320101	82	0513094-820101
34	0513094-340101	84	0513094-840101
36	0513094-360101	86	0513094-860101
38	0513094-380101	88	0513094-880101
40	0513094-400101	90	0513094-900101
42	0513094-420101	92	0513094-920101
44	0513094-440101	94	0513094-940101
46	0513094-460101	96	0513094-960101
48	0513094-480101	98	0513094-980101
50	0513094-500101	100	0513094-1000101

1.27mm(0.05") Pitch  
Female Header Connector

0513111  
Vertical, Through Hole

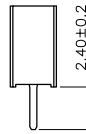
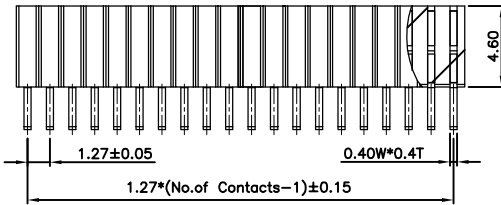
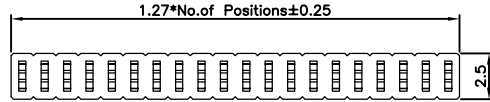
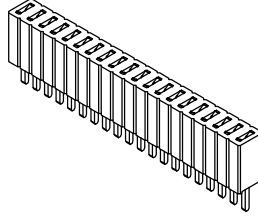

Specifications

Rating

Current Rating:1.0 Amp  
Voltage Rating:100V AC/DC  
Operating Temperature Range:-40°~+105°C

Electrical

Contact resistance:20m Ohm Max  
Insulator resistance:500M ohm min.  
Withstanding Voltage:500V AC/Minute

Material And Finish

Insulator:Nylon 6T UL94V-0 Color:Black  
Contact:Phosphor Bronze  
Plated:Gold Flash Over Nickel

No.of CKTS	Part No.	No.of CKTS	Part No.
		26	0513111-260101
02	0513111-020101	27	0513111-270101
03	0513111-030101	28	0513111-280101
04	0513111-040101	29	0513111-290101
05	0513111-050101	30	0513111-300101
06	0513111-060101	31	0513111-310101
07	0513111-070101	32	0513111-320101
08	0513111-080101	33	0513111-330101
09	0513111-090101	34	0513111-340101
10	0513111-100101	35	0513111-350101
11	0513111-110101	36	0513111-360101
12	0513111-120101	37	0513111-370101
13	0513111-130101	38	0513111-380101
14	0513111-140101	39	0513111-390101
15	0513111-150101	40	0513111-400101
16	0513111-160101	41	0513111-410101
17	0513111-170101	42	0513111-420101
18	0513111-180101	43	0513111-430101
19	0513111-190101	44	0513111-440101
20	0513111-200101	45	0513111-450101
21	0513111-210101	46	0513111-460101
22	0513111-220101	47	0513111-470101
23	0513111-230101	48	0513111-480101
24	0513111-240101	49	0513111-490101
25	0513111-250101	50	0513111-500101

1.27mm(0.05") Pitch  
Female Header Connector

0513101  
Vertical, Through Hole

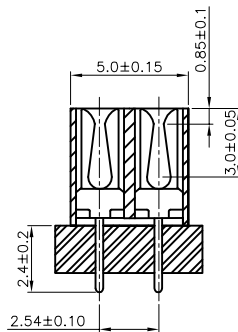
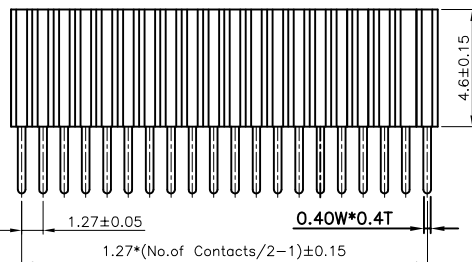
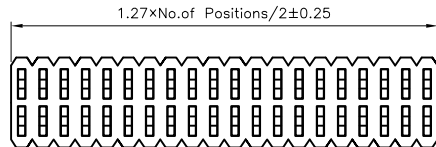

Specifications

Rating

Current Rating:1.0 Amp  
Voltage Rating:100V AC/DC  
Operating Temperature Range:-40°~+105°C

Electrical

Contact resistance:20m Ohm Max  
Insulator resistance:500M ohm min.  
Withstanding Voltage:500V AC/Minute

Material And Finish

Insulator:Nylon 6T UL94V-0 Color:Black  
Contact:Phosphor Bronze  
Plated:Gold Flash Over Nickel

No.of CKTS	Part No.	No.of CKTS	Part No.
		52	0513101-520101
04	0513101-040101	54	0513101-540101
06	0513101-060101	56	0513101-560101
08	0513101-080101	58	0513101-580101
10	0513101-100101	60	0513101-600101
12	0513101-120101	62	0513101-620101
14	0513101-140101	64	0513101-640101
16	0513101-160101	66	0513101-660101
18	0513101-180101	68	0513101-680101
20	0513101-200101	70	0513101-700101
22	0513101-220101	72	0513101-720101
24	0513101-240101	74	0513101-740101
26	0513101-260101	76	0513101-760101
28	0513101-280101	78	0513101-780101
30	0513101-300101	80	0513101-800101
32	0513101-320101	82	0513101-820101
34	0513101-340101	84	0513101-840101
36	0513101-360101	86	0513101-860101
38	0513101-380101	88	0513101-880101
40	0513101-400101	90	0513101-900101
42	0513101-420101	92	0513101-920101
44	0513101-440101	94	0513101-940101
46	0513101-460101	96	0513101-960101
48	0513101-480101	98	0513101-980101
50	0513101-500101	100	0513101-1000101

1.27mm(0.05") Pitch  
Female Header Connector

0513131  
Vertical, Through Hole

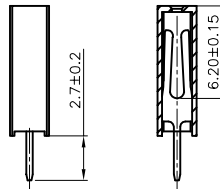
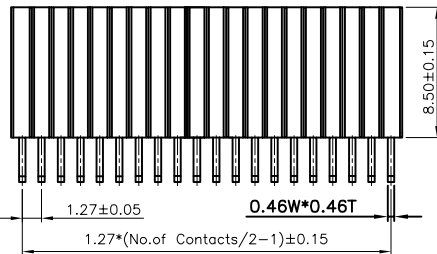
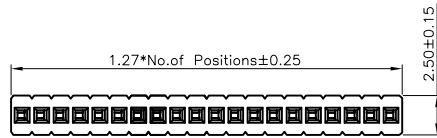

Specifications

Rating

Current Rating:1.0 Amp  
Voltage Rating:100V AC/DC  
Operating Temperature Range:-40°~+105°C

Electrical

Contact resistance:20m Ohm Max  
Insulator resistance:500M ohm min.  
Withstanding Voltage:500V AC/Minute

Material And Finish

Insulator:Nylon 6T UL94V-0 Color:Black  
Contact:Phosphor Bronze  
Plated:Gold Flash Over Nickel

No.of CKTS	Part No.	No.of CKTS	Part No.
02	0513131-020101	26	0513131-260101
03	0513131-030101	27	0513131-270101
04	0513131-040101	28	0513131-280101
05	0513131-050101	29	0513131-290101
06	0513131-060101	30	0513131-300101
07	0513131-070101	31	0513131-310101
08	0513131-080101	32	0513131-320101
09	0513131-090101	33	0513131-330101
10	0513131-100101	34	0513131-340101
11	0513131-110101	35	0513131-350101
12	0513131-120101	36	0513131-360101
13	0513131-130101	37	0513131-370101
14	0513131-140101	38	0513131-380101
15	0513131-150101	39	0513131-390101
16	0513131-160101	40	0513131-400101
17	0513131-170101	41	0513131-410101
18	0513131-180101	42	0513131-420101
19	0513131-190101	43	0513131-430101
20	0513131-200101	44	0513131-440101
21	0513131-210101	45	0513131-450101
22	0513131-220101	46	0513131-460101
23	0513131-230101	47	0513131-470101
24	0513131-240101	48	0513131-480101
25	0513131-250101	49	0513131-490101
		50	0513131-500101

1.27mm(0.05") Pitch  
Female Header Connector

0513121  
Vertical, Through Hole

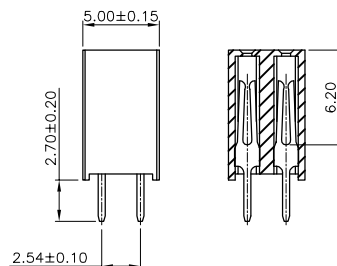
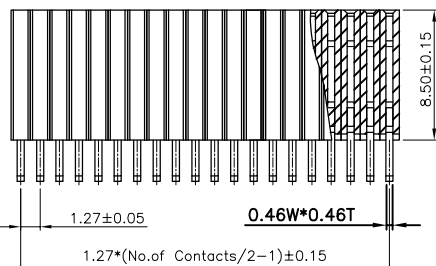
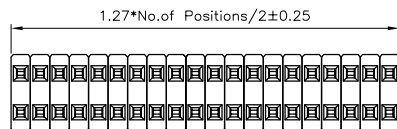
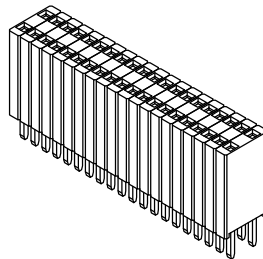

Specifications

Rating

Current Rating:1.0 Amp  
Voltage Rating:100V AC/DC  
Operating Temperature Range:-40°~+105°C

Electrical

Contact resistance:20m Ohm Max  
Insulator resistance:500M ohm min.  
Withstanding Voltage:500V AC/Minute

Material And Finish

Insulator:Nylon 6T UL94V-0 Color:Black  
Contact:Phosphor Bronze  
Plated:Gold Flash Over Nickel

No.of CKTS	Part No.	No.of CKTS	Part No.
04	0513121-040101	52	0513121-520101
06	0513121-060101	54	0513121-540101
08	0513121-080101	56	0513121-560101
10	0513121-100101	58	0513121-580101
12	0513121-120101	60	0513121-600101
14	0513121-140101	62	0513121-620101
16	0513121-160101	64	0513121-640101
18	0513121-180101	66	0513121-660101
20	0513121-200101	68	0513121-680101
22	0513121-220101	70	0513121-700101
24	0513121-240101	72	0513121-720101
26	0513121-260101	74	0513121-740101
28	0513121-280101	76	0513121-760101
30	0513121-300101	78	0513121-780101
32	0513121-320101	80	0513121-800101
34	0513121-340101	82	0513121-820101
36	0513121-360101	84	0513121-840101
38	0513121-380101	86	0513121-860101
40	0513121-400101	88	0513121-880101
42	0513121-420101	90	0513121-900101
44	0513121-440101	92	0513121-920101
46	0513121-460101	94	0513121-940101
48	0513121-480101	96	0513121-960101
50	0513121-500101	98	0513121-980101
		100	0513121-1000101

1.27mm(0.05") Pitch  
Female Header Connector

0513158  
Vertical, SMT

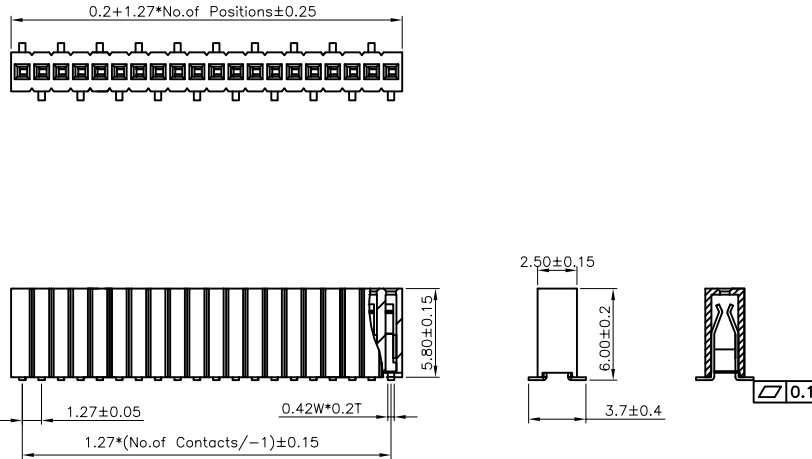

Specifications

Rating

Current Rating:1.0 Amp  
Voltage Rating:100V AC/DC  
Operating Temperature Range:-40°~+105°C

Electrical

Contact resistance:20m Ohm Max  
Insulator resistance:500M ohm min.  
Withstanding Voltage:500V AC/Minute

Material And Finish

Insulator:Nylon 6T UL94V-0 Color:Black  
Contact:Phosphor Bronze  
Plated:Gold Flash Over Nickel

No.of CKTS	Part No.	No.of CKTS	Part No.
		25	0513158-260101
02	0513158-020101	27	0513158-270101
03	0513158-030101	28	0513158-280101
04	0513158-040101	29	0513158-290101
05	0513158-050101	30	0513158-300101
06	0513158-060101	31	0513158-310101
07	0513158-070101	32	0513158-320101
08	0513158-080101	33	0513158-330101
09	0513158-090101	34	0513158-340101
10	0513158-100101	35	0513158-350101
11	0513158-110101	36	0513158-360101
12	0513158-120101	37	0513158-370101
13	0513158-130101	38	0513158-380101
14	0513158-140101	39	0513158-390101
15	0513158-150101	40	0513158-400101
16	0513158-160101	41	0513158-410101
17	0513158-170101	42	0513158-420101
18	0513158-180101	43	0513158-430101
19	0513158-190101	44	0513158-440101
20	0513158-200101	45	0513158-450101
21	0513158-210101	46	0513158-460101
22	0513158-220101	47	0513158-470101
23	0513158-230101	48	0513158-480101
24	0513158-240101	49	0513158-490101
25	0513158-250101	50	0513158-500101

1.27mm(0.05") Pitch  
Female Header Connector

0513146  
Vertical, SMT

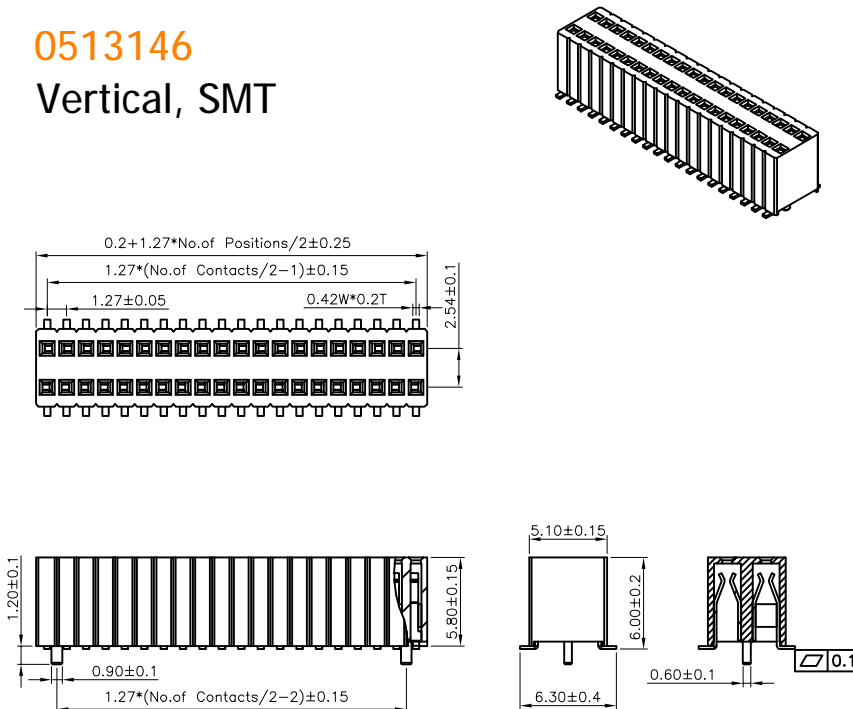

Specifications

Rating

Current Rating:1.0 Amp  
Voltage Rating:100V AC/DC  
Operating Temperature Range:-40°~+105°C

Electrical

Contact resistance:20m Ohm Max  
Insulator resistance:500M ohm min.  
Withstanding Voltage:500V AC/Minute

Material And Finish

Insulator:Nylon 6T UL94V-0 Color:Black  
Contact:Phosphor Bronze  
Plated:Gold Flash Over Nickel

No.of CKTS	Part No.	No.of CKTS	Part No.
		52	0513146-520101
04	0513146-040101	54	0513146-540101
06	0513146-060101	56	0513146-560101
08	0513146-080101	58	0513146-580101
10	0513146-100101	60	0513146-600101
12	0513146-120101	62	0513146-620101
14	0513146-140101	64	0513146-640101
16	0513146-160101	66	0513146-660101
18	0513146-180101	68	0513146-680101
20	0513146-200101	70	0513146-700101
22	0513146-220101	72	0513146-720101
24	0513146-240101	74	0513146-740101
26	0513146-260101	76	0513146-760101
28	0513146-280101	78	0513146-780101
30	0513146-300101	80	0513146-800101
32	0513146-320101	82	0513146-820101
34	0513146-340101	84	0513146-840101
36	0513146-360101	86	0513146-860101
38	0513146-380101	88	0513146-880101
40	0513146-400101	90	0513146-900101
42	0513146-420101	92	0513146-920101
44	0513146-440101	94	0513146-940101
46	0513146-460101	96	0513146-960101
48	0513146-480101	98	0513146-980101
50	0513146-500101	100	0513146-1000101

2.00mm(0.079") Pitch  
Female Header Connector

0520011

Vertical, Through Hole

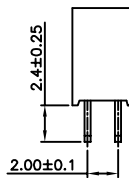
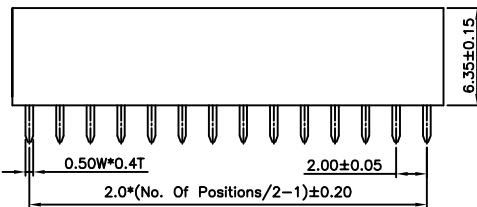
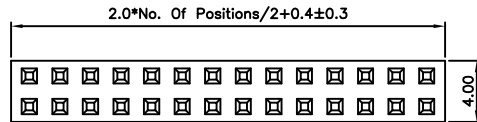

Specifications

Rating

Current Rating:2.0 Amp  
Voltage Rating:150V AC/DC  
Operating Temperature Range:-40°~+105°C

Electrical

Contact resistance:20m Ohm Max  
Insulator resistance:1000M ohm min.  
Withstanding Voltage:500V AC/Minute

Material And Finish

Insulator:Nylon 6T UL94V-0 Color:Black  
Contact:Phosphor Bronze  
Plated:Gold Flash Over Nickel

No.of CKTS	Part No.	No.of CKTS	Part No.
04	0520011-040102	42	0520011-420102
06	0520011-060102	44	0520011-440102
08	0520011-080102	46	0520011-460102
10	0520011-100102	48	0520011-480102
12	0520011-120102	50	0520011-500102
14	0520011-140102	52	0520011-520102
16	0520011-160102	54	0520011-540102
18	0520011-180102	56	0520011-560102
20	0520011-200102	58	0520011-580102
22	0520011-220102	60	0520011-600102
24	0520011-240102	62	0520011-620102
26	0520011-260102	64	0520011-640102
28	0520011-280102	66	0520011-660102
30	0520011-300102	68	0520011-680102
32	0520011-320102	70	0520011-700102
34	0520011-340102	72	0520011-720102
36	0520011-360102	74	0520011-740102
38	0520011-380102	76	0520011-760102
40	0520011-400102	78	0520011-780102
		80	0520011-800102

2.00mm(0.079") Pitch  
Female Header Connector

0520011

Vertical, Through Hole

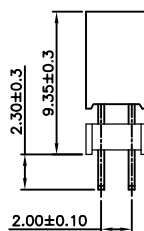
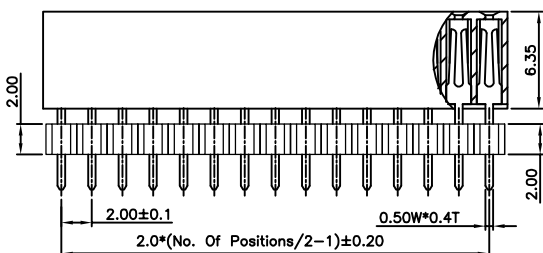
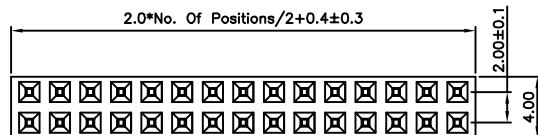

Specifications

Rating

Current Rating:2.0 Amp  
Voltage Rating:150V AC/DC  
Operating Temperature Range:-40°~+105°C

Electrical

Contact resistance:20m Ohm Max  
Insulator resistance:1000M ohm min.  
Withstanding Voltage:500V AC/Minute

Material And Finish

Insulator:Nylon 6T UL94V-0 Color:Black  
Contact:Phosphor Bronze  
Plated:Gold Flash Over Nickel

No.of CKTS	Part No.	No.of CKTS	Part No.
04	0520011-040102	42	0520011-420102
06	0520011-060102	44	0520011-440102
08	0520011-080102	46	0520011-460102
10	0520011-100102	48	0520011-480102
12	0520011-120102	50	0520011-500102
14	0520011-140102	52	0520011-520102
16	0520011-160102	54	0520011-540102
18	0520011-180102	56	0520011-560102
20	0520011-200102	58	0520011-580102
22	0520011-220102	60	0520011-600102
24	0520011-240102	62	0520011-620102
26	0520011-260102	64	0520011-640102
28	0520011-280102	66	0520011-660102
30	0520011-300102	68	0520011-680102
32	0520011-320102	70	0520011-700102
34	0520011-340102	72	0520011-720102
36	0520011-360102	74	0520011-740102
38	0520011-380102	76	0520011-760102
40	0520011-400102	78	0520011-780102
		80	0520011-800102

2.00mm(0.079") Pitch  
Female Header Connector

0520012  
Right Angle, Through Hole

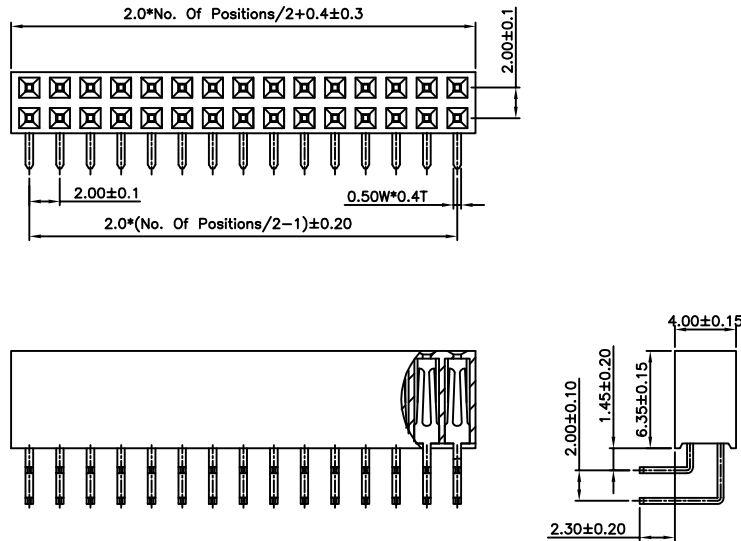

Specifications

Rating

Current Rating:2.0 Amp  
Voltage Rating:150V AC/DC  
Operating Temperature Range:-40°~+105°C

Electrical

Contact resistance:20m Ohm Max  
Insulator resistance:1000M ohm min.  
Withstanding Voltage:500V AC/Minute

Material And Finish

Insulator:Nylon 6T UL94V-0 Color:Black  
Contact:Phosphor Bronze  
Plated:Gold Flash Over Nickel

No.of CKTS	Part No.	No.of CKTS	Part No.
04	0520013-040104	42	0520013-420104
06	0520013-060104	44	0520013-440104
08	0520013-080104	46	0520013-460104
10	0520013-100104	48	0520013-480104
12	0520013-120104	50	0520013-500104
14	0520013-140104	52	0520013-520104
16	0520013-160104	54	0520013-540104
18	0520013-180104	56	0520013-560104
20	0520013-200104	58	0520013-580104
22	0520013-220104	60	0520013-600104
24	0520013-240104	62	0520013-620104
26	0520013-260104	64	0520013-640104
28	0520013-280104	66	0520013-660104
30	0520013-300104	68	0520013-680104
32	0520013-320104	70	0520013-700104
34	0520013-340104	72	0520013-720104
36	0520013-360104	74	0520013-740104
38	0520013-380104	76	0520013-760104
40	0520013-400104	78	0520013-780104
		80	0520013-800104

2.00mm(0.079") Pitch  
Female Header Connector

0520013  
Vertical, SMT

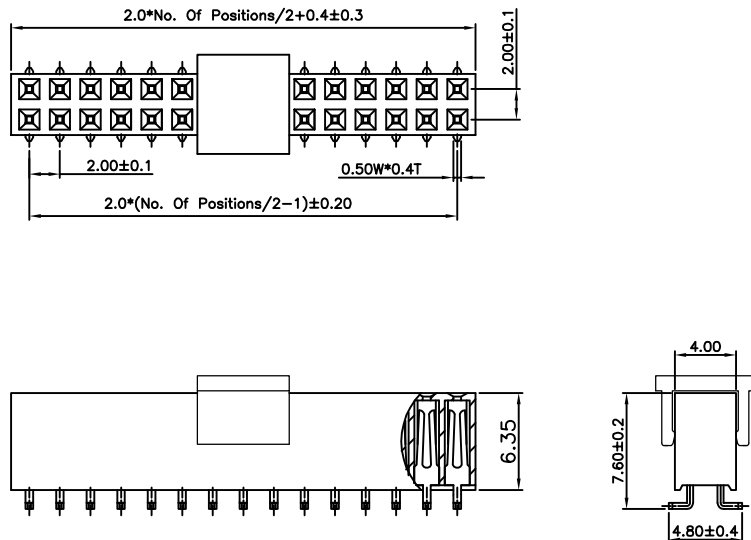

Specifications

Rating

Current Rating:2.0 Amp  
Voltage Rating:150V AC/DC  
Operating Temperature Range:-40°~+105°C

Electrical

Contact resistance:20m Ohm Max  
Insulator resistance:1000M ohm min.  
Withstanding Voltage:500V AC/Minute

Material And Finish

Insulator:Nylon 6T UL94V-0 Color:Black  
Contact:Phosphor Bronze  
Plated:Gold Flash Over Nickel

No.of CKTS	Part No.	No.of CKTS	Part No.
04	0520013-040104	42	0520013-420104
06	0520013-060104	44	0520013-440104
08	0520013-080104	46	0520013-460104
10	0520013-100104	48	0520013-480104
12	0520013-120104	50	0520013-500104
14	0520013-140104	52	0520013-520104
16	0520013-160104	54	0520013-540104
18	0520013-180104	56	0520013-560104
20	0520013-200104	58	0520013-580104
22	0520013-220104	60	0520013-600104
24	0520013-240104	62	0520013-620104
26	0520013-260104	64	0520013-640104
28	0520013-280104	66	0520013-660104
30	0520013-300104	68	0520013-680104
32	0520013-320104	70	0520013-700104
34	0520013-340104	72	0520013-720104
36	0520013-360104	74	0520013-740104
38	0520013-380104	76	0520013-760104
40	0520013-400104	78	0520013-780104
		80	0520013-800104



2.00mm(0.079") Pitch  
Female Header Connector

0520021

Vertical, Through Hole

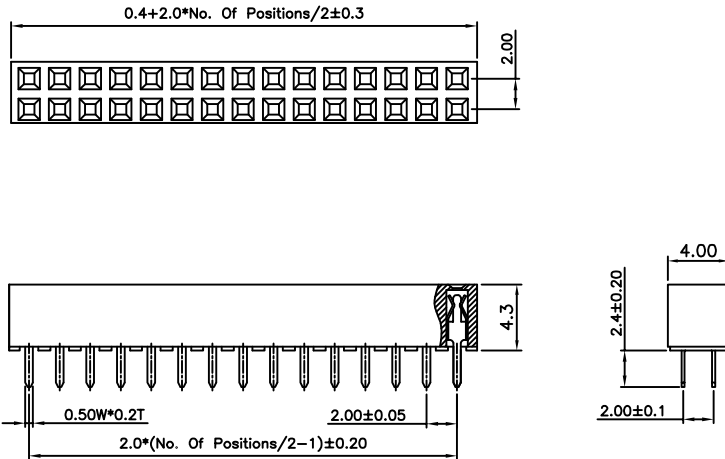

Specifications

Rating

Current Rating:2.0 Amp  
Voltage Rating:150V AC/DC  
Operating Temperature Range:-40°~+105°C

Electrical

Contact resistance:20m Ohm Max  
Insulator resistance:1000M ohm min.  
Withstanding Voltage:500V AC/Minute

Material And Finish

Insulator:Nylon 6T UL94V-0 Color:Black  
Contact:Phosphor Bronze  
Plated:Gold Flash Over Nickel

No. of CKTS	Part No.	No. of CKTS	Part No.
04	0520021-040102	42	0520021-420102
06	0520021-060102	44	0520021-440102
08	0520021-080102	46	0520021-460102
10	0520021-100102	48	0520021-480102
12	0520021-120102	50	0520021-500102
14	0520021-140102	52	0520021-520102
16	0520021-160102	54	0520021-540102
18	0520021-180102	56	0520021-560102
20	0520021-200102	58	0520021-580102
22	0520021-220102	60	0520021-600102
24	0520021-240102	62	0520021-620102
26	0520021-260102	64	0520021-640102
28	0520021-280102	66	0520021-660102
30	0520021-300102	68	0520021-680102
32	0520021-320102	70	0520021-700102
34	0520021-340102	72	0520021-720102
36	0520021-360102	74	0520021-740102
38	0520021-380102	76	0520021-760102
40	0520021-400102	78	0520021-780102
		80	0520021-800102

2.00mm(0.079") Pitch  
Female Header Connector

0520026

Vertical, SMT

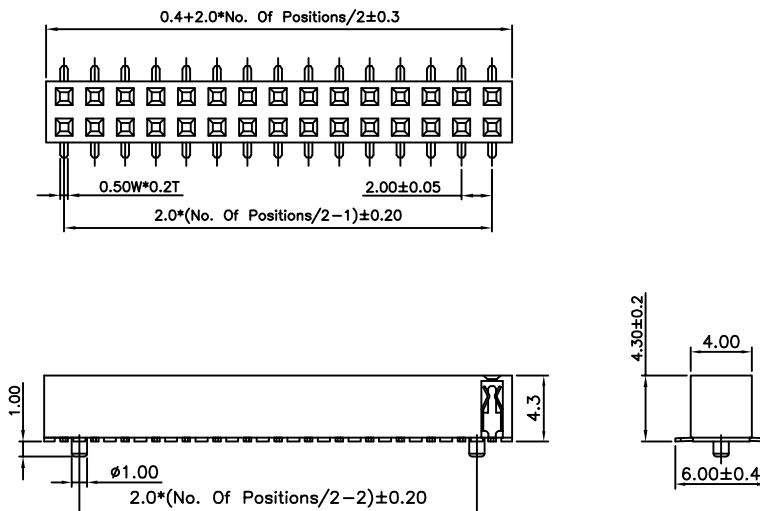

Specifications

Rating

Current Rating:2.0 Amp  
Voltage Rating:150V AC/DC  
Operating Temperature Range:-40°~+105°C

Electrical

Contact resistance:20m Ohm Max  
Insulator resistance:1000M ohm min.  
Withstanding Voltage:500V AC/Minute

Material And Finish

Insulator:Nylon 6T UL94V-0 Color:Black  
Contact:Phosphor Bronze  
Plated:Gold Flash Over Nickel

No. of CKTS	Part No.	No. of CKTS	Part No.
04	0520026-040101	42	0520026-420101
06	0520026-060101	44	0520026-440101
08	0520026-080101	46	0520026-460101
10	0520026-100101	48	0520026-480101
12	0520026-120101	50	0520026-500101
14	0520026-140101	52	0520026-520101
16	0520026-160101	54	0520026-540101
18	0520026-180101	56	0520026-560101
20	0520026-200101	58	0520026-580101
22	0520026-220101	60	0520026-600101
24	0520026-240101	62	0520026-620101
26	0520026-260101	64	0520026-640101
28	0520026-280101	66	0520026-660101
30	0520026-300101	68	0520026-680101
32	0520026-320101	70	0520026-700101
34	0520026-340101	72	0520026-720101
36	0520026-360101	74	0520026-740101
38	0520026-380101	76	0520026-760101
40	0520026-400101	78	0520026-780101
		80	0520026-800101

2.00mm(0.079") Pitch  
Female Header Connector

0520031

Vertical, Through Hole

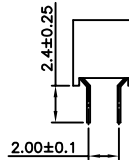
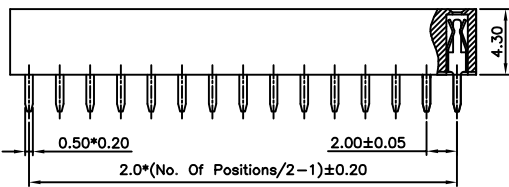
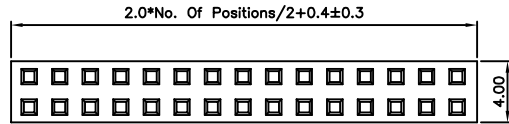

Specifications

Rating

Current Rating:2.0 Amp  
Voltage Rating:150V AC/DC  
Operating Temperature Range:-40°~+105°C

Electrical

Contact resistance:20m Ohm Max  
Insulator resistance:1000M ohm min.  
Withstanding Voltage:500V AC/Minute

Material And Finish

Insulator:Nylon 6T UL94V-0 Color:Black  
Contact:Phosphor Bronze  
Plated:Gold Flash Over Nickel

No.of CKTS	Part No.	No.of CKTS	Part No.
04	0520031-040102	42	0520031-420102
06	0520031-060102	44	0520031-440102
08	0520031-080102	46	0520031-460102
10	0520031-100102	48	0520031-480102
12	0520031-120102	50	0520031-500102
14	0520031-140102	52	0520031-520102
16	0520031-160102	54	0520031-540102
18	0520031-180102	56	0520031-560102
20	0520031-200102	58	0520031-580102
22	0520031-220102	60	0520031-600102
24	0520031-240102	62	0520031-620102
26	0520031-260102	64	0520031-640102
28	0520031-280102	66	0520031-660102
30	0520031-300102	68	0520031-680102
32	0520031-320102	70	0520031-700102
34	0520031-340102	72	0520031-720102
36	0520031-360102	74	0520031-740102
38	0520031-380102	76	0520031-760102
40	0520031-400102	78	0520031-780102
		80	0520031-800102

2.00mm(0.079") Pitch  
Female Header Connector

0520036

Vertical, SMT

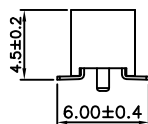
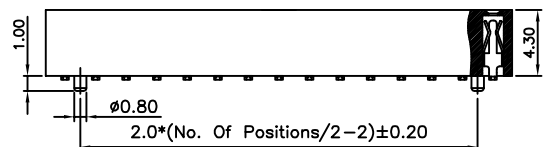
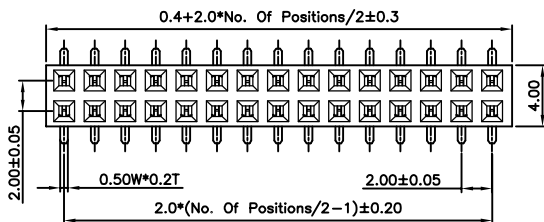

Specifications

Rating

Current Rating:2.0 Amp  
Voltage Rating:150V AC/DC  
Operating Temperature Range:-40°~+105°C

Electrical

Contact resistance:20m Ohm Max  
Insulator resistance:1000M ohm min.  
Withstanding Voltage:500V AC/Minute

Material And Finish

Insulator:Nylon 6T UL94V-0 Color:Black  
Contact:Phosphor Bronze  
Plated:Gold Flash Over Nickel

No.of CKTS	Part No.	No.of CKTS	Part No.
04	0520036-040101	42	0520036-420101
06	0520036-060101	44	0520036-440101
08	0520036-080101	46	0520036-460101
10	0520036-100101	48	0520036-480101
12	0520036-120101	50	0520036-500101
14	0520036-140101	52	0520036-520101
16	0520036-160101	54	0520036-540101
18	0520036-180101	56	0520036-560101
20	0520036-200101	58	0520036-580101
22	0520036-220101	60	0520036-600101
24	0520036-240101	62	0520036-620101
26	0520036-260101	64	0520036-640101
28	0520036-280101	66	0520036-660101
30	0520036-300101	68	0520036-680101
32	0520036-320101	70	0520036-700101
34	0520036-340101	72	0520036-720101
36	0520036-360101	74	0520036-740101
38	0520036-380101	76	0520036-760101
40	0520036-400101	78	0520036-780101
		80	0520036-800101

2.00mm(0.079") Pitch  
Female Header Connector

0520041

Vertical, Through Hole

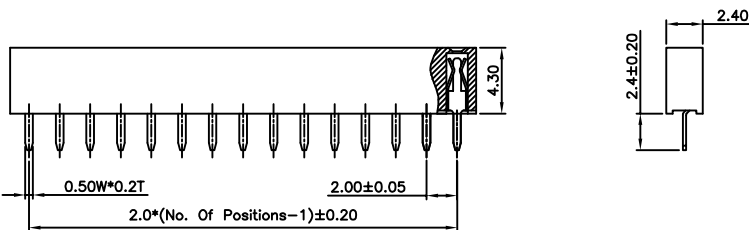
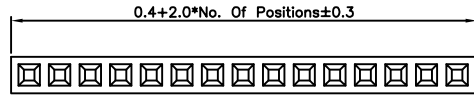

Specifications

Rating

Current Rating:2.0 Amp  
Voltage Rating:150V AC/DC  
Operating Temperature Range:-40°~+105°C

Electrical

Contact resistance:20m Ohm Max  
Insulator resistance:1000M ohm min.  
Withstanding Voltage:500V AC/Minute

Material And Finish

Insulator:Nylon 6T UL94V-0 Color:Black  
Contact:Phosphor Bronze  
Plated:Gold Flash Over Nickel

No.of CKTS	Part No.	No.of CKTS	Part No.
		21	0520041-210102
02	0520041-020102	22	0520041-220102
03	0520041-030102	23	0520041-230102
04	0520041-040102	24	0520041-240102
05	0520041-050102	25	0520041-250102
06	0520041-060102	26	0520041-260102
07	0520041-070102	27	0520041-270102
08	0520041-080102	28	0520041-280102
09	0520041-090102	29	0520041-290102
10	0520041-100102	30	0520041-300102
11	0520041-110102	31	0520041-310102
12	0520041-120102	32	0520041-320102
13	0520041-130102	33	0520041-330102
14	0520041-140102	34	0520041-340102
15	0520041-150102	35	0520041-350102
16	0520041-160102	36	0520041-360102
17	0520041-170102	37	0520041-370102
18	0520041-180102	38	0520041-380102
19	0520041-190102	39	0520041-390102
20	0520041-200102	40	0520041-400102

2.00mm(0.079") Pitch  
Female Header Connector

0520042

Right Angle, Through Hole

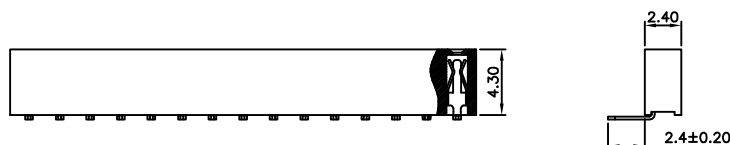
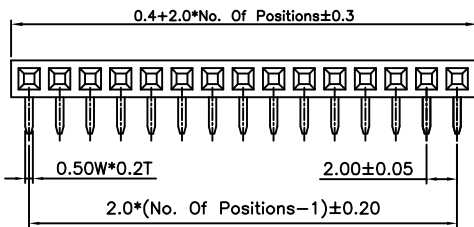

Specifications

Rating

Current Rating:2.0 Amp  
Voltage Rating:150V AC/DC  
Operating Temperature Range:-40°~+105°C

Electrical

Contact resistance:20m Ohm Max  
Insulator resistance:1000M ohm min.  
Withstanding Voltage:500V AC/Minute

Material And Finish

Insulator:Nylon 6T UL94V-0 Color:Black  
Contact:Phosphor Bronze  
Plated:Gold Flash Over Nickel

No.of CKTS	Part No.	No.of CKTS	Part No.
		21	0520042-210101
02	0520042-020101	22	0520042-220101
03	0520042-030101	23	0520042-230101
04	0520042-040101	24	0520042-240101
05	0520042-050101	25	0520042-250101
06	0520042-060101	26	0520042-260101
07	0520042-070101	27	0520042-270101
08	0520042-080101	28	0520042-280101
09	0520042-090101	29	0520042-290101
10	0520042-100101	30	0520042-300101
11	0520042-110101	31	0520042-310101
12	0520042-120101	32	0520042-320101
13	0520042-130101	33	0520042-330101
14	0520042-140101	34	0520042-340101
15	0520042-150101	35	0520042-350101
16	0520042-160101	36	0520042-360101
17	0520042-170101	37	0520042-370101
18	0520042-180101	38	0520042-380101
19	0520042-190101	39	0520042-390101
20	0520042-200101	40	0520042-400101

2.00mm(0.079") Pitch  
Female Header Connector

0520048  
Vertical, SMT

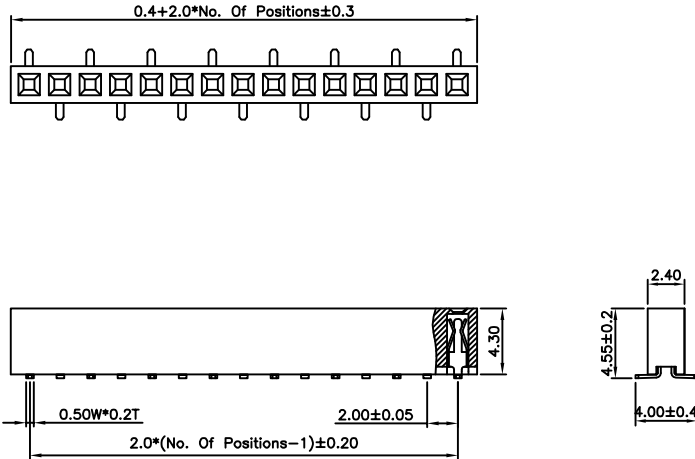

Specifications

Rating

Current Rating:2.0 Amp  
Voltage Rating:150V AC/DC  
Operating Temperature Range:-40°~+105°C

Electrical

Contact resistance:20m Ohm Max  
Insulator resistance:1000M ohm min.  
Withstanding Voltage:500V AC/Minute

Material And Finish

Insulator:Nylon 6T UL94V-0 Color:Black  
Contact:Phosphor Bronze  
Plated:Gold Flash Over Nickel

No.of CKTS	Part No.	No.of CKTS	Part No.
		21	0520048-210101
02	0520048-020101	22	0520048-220101
03	0520048-030101	23	0520048-230101
04	0520048-040101	24	0520048-240101
05	0520048-050101	25	0520048-250101
06	0520048-060101	26	0520048-260101
07	0520048-070101	27	0520048-270101
08	0520048-080101	28	0520048-280101
09	0520048-090101	29	0520048-290101
10	0520048-100101	30	0520048-300101
11	0520048-110101	31	0520048-310101
12	0520048-120101	32	0520048-320101
13	0520048-130101	33	0520048-330101
14	0520048-140101	34	0520048-340101
15	0520048-150101	35	0520048-350101
16	0520048-160101	36	0520048-360101
17	0520048-170101	37	0520048-370101
18	0520048-180101	38	0520048-380101
19	0520048-190101	39	0520048-390101
20	0520048-200101	40	0520048-400101

2.00mm(0.079") Pitch  
Female Header Connector

0520049  
Vertical, SMT

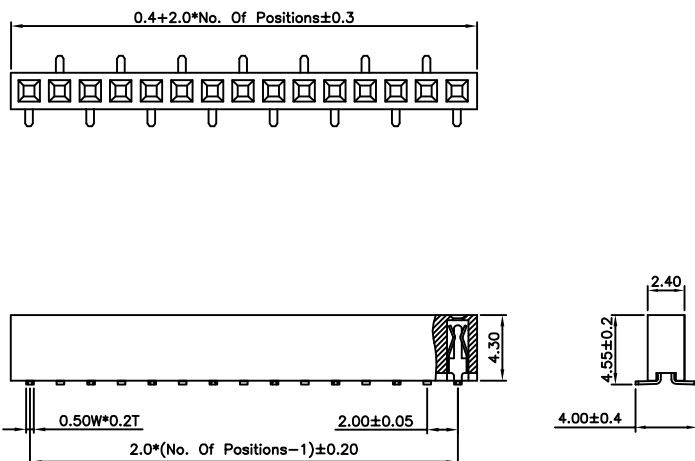

Specifications

Rating

Current Rating:2.0 Amp  
Voltage Rating:150V AC/DC  
Operating Temperature Range:-40°~+105°C

Electrical

Contact resistance:20m Ohm Max  
Insulator resistance:1000M ohm min.  
Withstanding Voltage:500V AC/Minute

Material And Finish

Insulator:Nylon 6T UL94V-0 Color:Black  
Contact:Phosphor Bronze  
Plated:Gold Flash Over Nickel

No.of CKTS	Part No.	No.of CKTS	Part No.
		21	0520049-210101
02	0520049-020101	22	0520049-220101
03	0520049-030101	23	0520049-230101
04	0520049-040101	24	0520049-240101
05	0520049-050101	25	0520049-250101
06	0520049-060101	26	0520049-260101
07	0520049-070101	27	0520049-270101
08	0520049-080101	28	0520049-280101
09	0520049-090101	29	0520049-290101
10	0520049-100101	30	0520049-300101
11	0520049-110101	31	0520049-310101
12	0520049-120101	32	0520049-320101
13	0520049-130101	33	0520049-330101
14	0520049-140101	34	0520049-340101
15	0520049-150101	35	0520049-350101
16	0520049-160101	36	0520049-360101
17	0520049-170101	37	0520049-370101
18	0520049-180101	38	0520049-380101
19	0520049-190101	39	0520049-390101
20	0520049-200101	40	0520049-400101

2.00mm(0.079") Pitch  
Female Header Connector

0520058  
Vertical, SMT

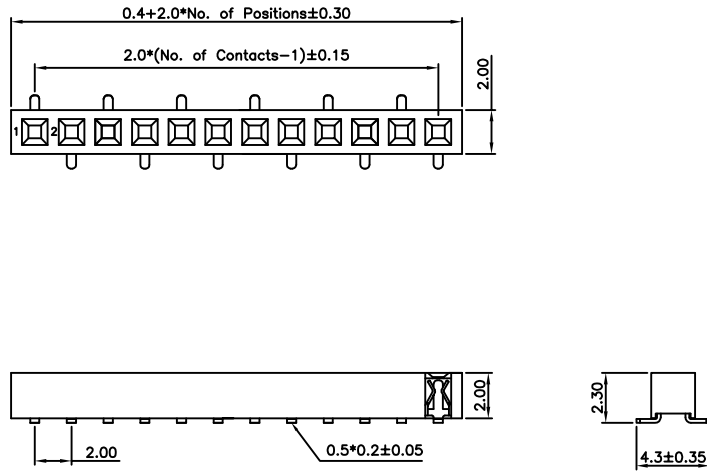

Specifications

Rating

Current Rating:2.0 Amp  
Voltage Rating:150V AC/DC  
Operating Temperature Range:-40~+105°C

Electrical

Contact resistance:20m Ohm Max  
Insulator resistance:1000M ohm min.  
Withstanding Voltage:500V AC/Minute

Material And Finish

Insulator:Nylon 6T UL94V-0 Color:Black  
Contact:Phosphor Bronze  
Plated:Gold Flash Over Nickel

No.of CKTS	Part No.	No.of CKTS	Part No.
		21	0520058-210101
02	0520058-020101	22	0520058-220101
03	0520058-030101	23	0520058-230101
04	0520058-040101	24	0520058-240101
05	0520058-050101	25	0520058-250101
06	0520058-060101	26	0520058-260101
07	0520058-070101	27	0520058-270101
08	0520058-080101	28	0520058-280101
09	0520058-090101	29	0520058-290101
10	0520058-100101	30	0520058-300101
11	0520058-110101	31	0520058-310101
12	0520058-120101	32	0520058-320101
13	0520058-130101	33	0520058-330101
14	0520058-140101	34	0520058-340101
15	0520058-150101	35	0520058-350101
16	0520058-160101	36	0520058-360101
17	0520058-170101	37	0520058-370101
18	0520058-180101	38	0520058-380101
19	0520058-190101	39	0520058-390101
20	0520058-200101	40	0520058-400101

2.00mm(0.079") Pitch  
Female Header Connector

0520059  
Vertical, SMT

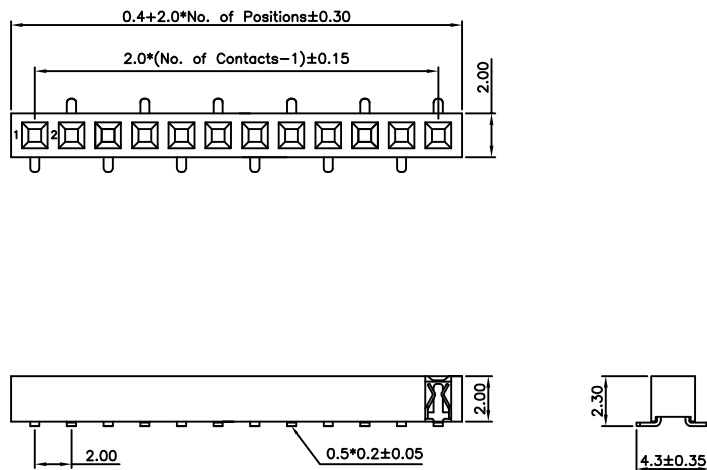

Specifications

Rating

Current Rating:2.0 Amp  
Voltage Rating:150V AC/DC  
Operating Temperature Range:-40~+105°C

Electrical

Contact resistance:20m Ohm Max  
Insulator resistance:1000M ohm min.  
Withstanding Voltage:500V AC/Minute

Material And Finish

Insulator:Nylon 6T UL94V-0 Color:Black  
Contact:Phosphor Bronze  
Plated:Gold Flash Over Nickel

No.of CKTS	Part No.	No.of CKTS	Part No.
		21	0520059-210101
02	0520059-020101	22	0520059-220101
03	0520059-030101	23	0520059-230101
04	0520059-040101	24	0520059-240101
05	0520059-050101	25	0520059-250101
06	0520059-060101	26	0520059-260101
07	0520059-070101	27	0520059-270101
08	0520059-080101	28	0520059-280101
09	0520059-090101	29	0520059-290101
10	0520059-100101	30	0520059-300101
11	0520059-110101	31	0520059-310101
12	0520059-120101	32	0520059-320101
13	0520059-130101	33	0520059-330101
14	0520059-140101	34	0520059-340101
15	0520059-150101	35	0520059-350101
16	0520059-160101	36	0520059-360101
17	0520059-170101	37	0520059-370101
18	0520059-180101	38	0520059-380101
19	0520059-190101	39	0520059-390101
20	0520059-200101	40	0520059-400101

2.00mm(0.079") Pitch  
Female Header Connector

0520061

Vertical, Through Hole

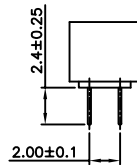
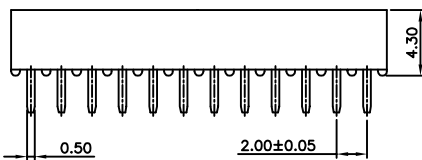
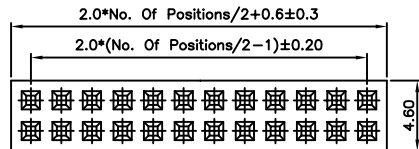

Specifications

Rating

Current Rating:2.0 Amp  
Voltage Rating:150V AC/DC  
Operating Temperature Range:-40°~+105°C

Electrical

Contact resistance:20m Ohm Max  
Insulator resistance:1000M ohm min.  
Withstanding Voltage:500V AC/Minute

Material And Finish

Insulator:Nylon 6T UL94V-0 Color:Black  
Contact:Phosphor Bronze  
Plated:Gold Flash Over Nickel

No.of CKTS	Part No.	No.of CKTS	Part No.
04	0520061-040102	42	0520061-420102
06	0520061-060102	44	0520061-440102
08	0520061-080102	46	0520061-460102
10	0520061-100102	48	0520061-480102
12	0520061-120102	50	0520061-500102
14	0520061-140102	52	0520061-520102
16	0520061-160102	54	0520061-540102
18	0520061-180102	56	0520061-560102
20	0520061-200102	58	0520061-580102
22	0520061-220102	60	0520061-600102
24	0520061-240102	62	0520061-620102
26	0520061-260102	64	0520061-640102
28	0520061-280102	66	0520061-660102
30	0520061-300102	68	0520061-680102
32	0520061-320102	70	0520061-700102
34	0520061-340102	72	0520061-720102
36	0520061-360102	74	0520061-740102
38	0520061-380102	76	0520061-760102
40	0520061-400102	78	0520061-780102
		80	0520061-800102

2.00mm(0.079") Pitch  
Female Header Connector

0520066

Vertical, SMT

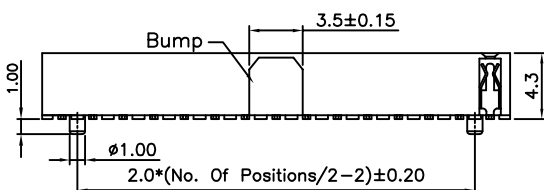
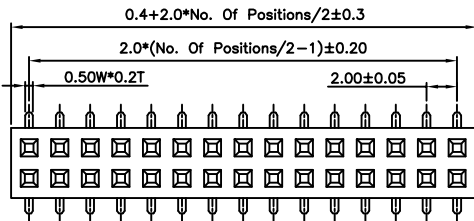

Specifications

Rating

Current Rating:2.0 Amp  
Voltage Rating:150V AC/DC  
Operating Temperature Range:-40°~+105°C

Electrical

Contact resistance:20m Ohm Max  
Insulator resistance:1000M ohm min.  
Withstanding Voltage:500V AC/Minute

Material And Finish

Insulator:Nylon 6T UL94V-0 Color:Black  
Contact:Phosphor Bronze  
Plated:Gold Flash Over Nickel

No.of CKTS	Part No.	No.of CKTS	Part No.
04	0520066-040101	42	0520066-420101
06	0520066-060101	44	0520066-440101
08	0520066-080101	46	0520066-460101
10	0520066-100101	48	0520066-480101
12	0520066-120101	50	0520066-500101
14	0520066-140101	52	0520066-520101
16	0520066-160101	54	0520066-540101
18	0520066-180101	56	0520066-560101
20	0520066-200101	58	0520066-580101
22	0520066-220101	60	0520066-600101
24	0520066-240101	62	0520066-620101
26	0520066-260101	64	0520066-640101
28	0520066-280101	66	0520066-660101
30	0520066-300101	68	0520066-680101
32	0520066-320101	70	0520066-700101
34	0520066-340101	72	0520066-720101
36	0520066-360101	74	0520066-740101
38	0520066-380101	76	0520066-760101
40	0520066-400101	78	0520066-780101
		80	0520066-800101

2.00mm(0.079") Pitch  
Female Header Connector

052006C1

Vertical, Through Hole

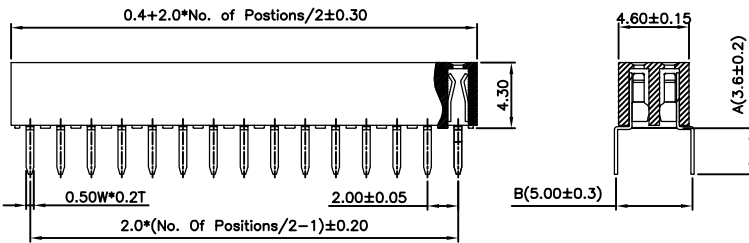
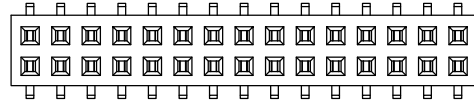
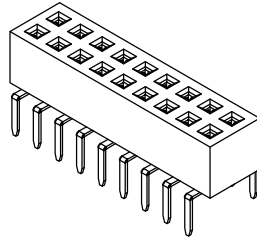

Specifications

Rating

Current Rating:2.0 Amp  
Voltage Rating:150V AC/DC  
Operating Temperature Range:-40°~+105°C

Electrical

Contact resistance:20m Ohm Max  
Insulator resistance:1000M ohm min.  
Withstanding Voltage:500V AC/Minute

Material And Finish

Insulator:PBT UL94V-0 Color:Black  
Contact:Phosphor Bronze  
Plated:Gold Flash Over Nickel

No. of CKTS	Part No.	No. of CKTS	Part No.
04	052006C1-040001	42	052006C1-420001
06	052006C1-060001	44	052006C1-440001
08	052006C1-080001	46	052006C1-460001
10	052006C1-100001	48	052006C1-480001
12	052006C1-120001	50	052006C1-500001
14	052006C1-140001	52	052006C1-520001
16	052006C1-160001	54	052006C1-540001
18	052006C1-180001	56	052006C1-560001
20	052006C1-200001	58	052006C1-580001
22	052006C1-220001	60	052006C1-600001
24	052006C1-240001	62	052006C1-620001
26	052006C1-260001	64	052006C1-640001
28	052006C1-280001	66	052006C1-660001
30	052006C1-300001	68	052006C1-680001
32	052006C1-320001	70	052006C1-700001
34	052006C1-340001	72	052006C1-720001
36	052006C1-360001	74	052006C1-740001
38	052006C1-380001	76	052006C1-760001
40	052006C1-400001	78	052006C1-780001
		80	052006C1-800001

2.00mm(0.079") Pitch  
Female Header Connector

052006C2

Vertical, Through Hole

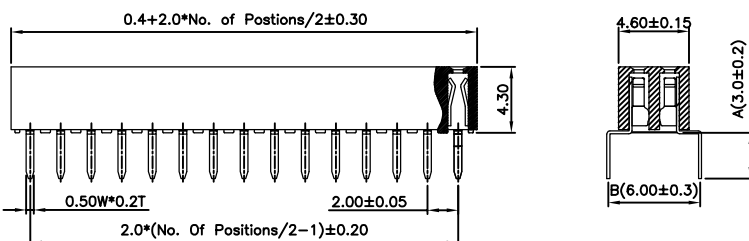
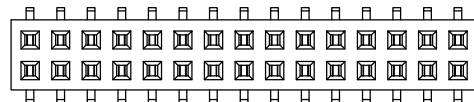
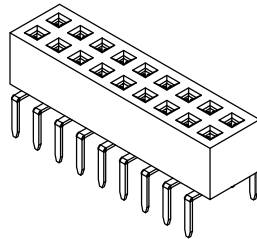

Specifications

Rating

Current Rating:2.0 Amp  
Voltage Rating:150V AC/DC  
Operating Temperature Range:-40°~+105°C

Electrical

Contact resistance:20m Ohm Max  
Insulator resistance:1000M ohm min.  
Withstanding Voltage:500V AC/Minute

Material And Finish

Insulator:PBT UL94V-0 Color:Black  
Contact:Phosphor Bronze  
Plated:Gold Flash Over Nickel

No. of CKTS	Part No.	No. of CKTS	Part No.
04	052006C2-040001	42	052006C2-420001
06	052006C2-060001	44	052006C2-440001
08	052006C2-080001	46	052006C2-460001
10	052006C2-100001	48	052006C2-480001
12	052006C2-120001	50	052006C2-500001
14	052006C2-140001	52	052006C2-520001
16	052006C2-160001	54	052006C2-540001
18	052006C2-180001	56	052006C2-560001
20	052006C2-200001	58	052006C2-580001
22	052006C2-220001	60	052006C2-600001
24	052006C2-240001	62	052006C2-620001
26	052006C2-260001	64	052006C2-640001
28	052006C2-280001	66	052006C2-660001
30	052006C2-300001	68	052006C2-680001
32	052006C2-320001	70	052006C2-700001
34	052006C2-340001	72	052006C2-720001
36	052006C2-360001	74	052006C2-740001
38	052006C2-380001	76	052006C2-760001
40	052006C2-400001	78	052006C2-780001
		80	052006C2-800001

2.00mm(0.079") Pitch  
Female Header Connector

0520083  
Vertical, SMT

Specifications

Rating

Current Rating:2.0 Amp  
Voltage Rating:150V AC/DC  
Operating Temperature Range:-40~+105°C

Electrical

Contact resistance:20m Ohm Max  
Insulator resistance:1000M ohm min.  
Withstanding Voltage:500V AC/Minute

Material And Finish

Insulator:Nylon 6T UL94V-0 Color:Black  
Contact:Phosphor Bronze  
Plated:Gold Flash Over Nickel

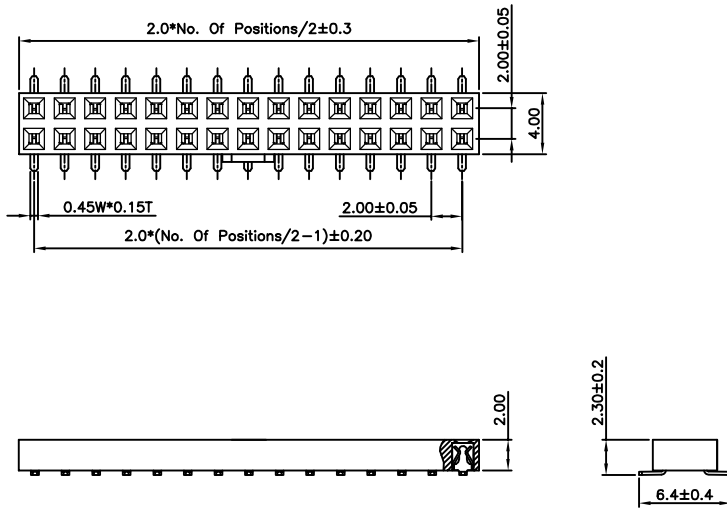

No.of CKTS	Part No.	No.of CKTS	Part No.
		42	0520083-420101
04	0520083-040101	44	0520083-440101
06	0520083-060101	46	0520083-460101
08	0520083-080101	48	0520083-480101
10	0520083-100101	50	0520083-500101
12	0520083-120101	52	0520083-520101
14	0520083-140101	54	0520083-540101
16	0520083-160101	56	0520083-560101
18	0520083-180101	58	0520083-580101
20	0520083-200101	60	0520083-600101
22	0520083-220101	62	0520083-620101
24	0520083-240101	64	0520083-640101
26	0520083-260101	66	0520083-660101
28	0520083-280101	68	0520083-680101
30	0520083-300101	70	0520083-700101
32	0520083-320101	72	0520083-720101
34	0520083-340101	74	0520083-740101
36	0520083-360101	76	0520083-760101
38	0520083-380101	78	0520083-780101
40	0520083-400101	80	0520083-800101

2.00mm(0.079") Pitch  
Female Header Connector

0520086  
Vertical, SMT

Specifications

Rating

Current Rating:2.0 Amp  
Voltage Rating:150V AC/DC  
Operating Temperature Range:-40~+105°C

Electrical

Contact resistance:20m Ohm Max  
Insulator resistance:1000M ohm min.  
Withstanding Voltage:500V AC/Minute

Material And Finish

Insulator:Nylon 6T UL94V-0 Color:Black  
Contact:Phosphor Bronze  
Plated:Gold Flash Over Nickel

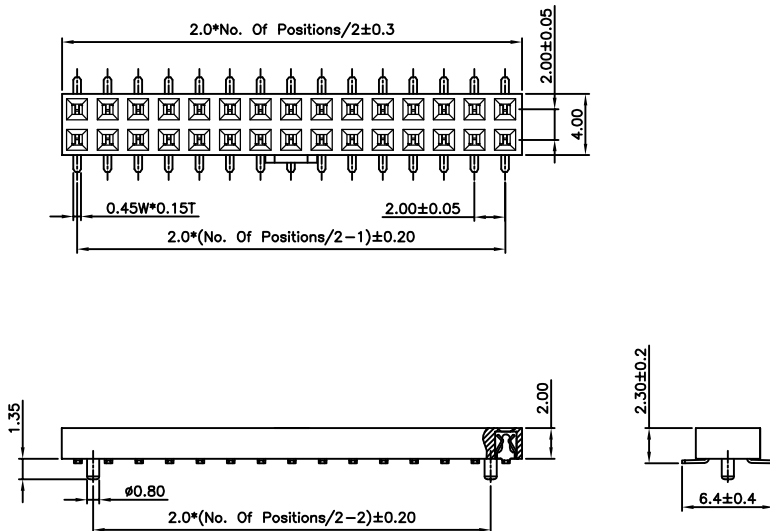

No.of CKTS	Part No.	No.of CKTS	Part No.
		42	0520086-420101
04	0520086-040101	44	0520086-440101
06	0520086-060101	46	0520086-460101
08	0520086-080101	48	0520086-480101
10	0520086-100101	50	0520086-500101
12	0520086-120101	52	0520086-520101
14	0520086-140101	54	0520086-540101
16	0520086-160101	56	0520086-560101
18	0520086-180101	58	0520086-580101
20	0520086-200101	60	0520086-600101
22	0520086-220101	62	0520086-620101
24	0520086-240101	64	0520086-640101
26	0520086-260101	66	0520086-660101
28	0520086-280101	68	0520086-680101
30	0520086-300101	70	0520086-700101
32	0520086-320101	72	0520086-720101
34	0520086-340101	74	0520086-740101
36	0520086-360101	76	0520086-760101
38	0520086-380101	78	0520086-780101
40	0520086-400101	80	0520086-800101



2.00mm(0.079") Pitch  
Female Header Connector

0520091

Vertical, Through Hole

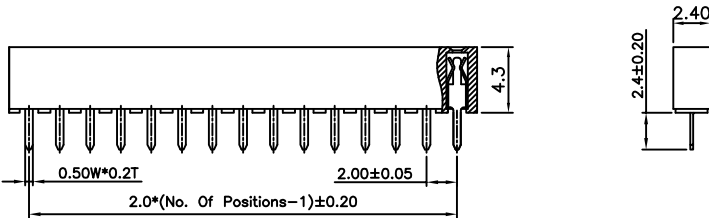
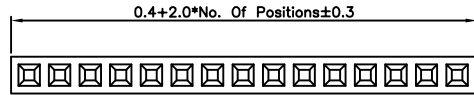

Specifications

Rating

Current Rating:2.0 Amp  
Voltage Rating:150V AC/DC  
Operating Temperature Range:-40~+105°C

Electrical

Contact resistance:20m Ohm Max  
Insulator resistance:1000M ohm min.  
Withstanding Voltage:500V AC/Minute

Material And Finish

Insulator:Nylon 6T UL94V-0 Color:Black  
Contact:Phosphor Bronze  
Plated:Gold Flash Over Nickel

No.of CKTS	Part No.	No.of CKTS	Part No.
		21	0520091-210102
02	0520091-020102	22	0520091-220102
03	0520091-030102	23	0520091-230102
04	0520091-040102	24	0520091-240102
05	0520091-050102	25	0520091-250102
06	0520091-060102	26	0520091-260102
07	0520091-070102	27	0520091-270102
08	0520091-080102	28	0520091-280102
09	0520091-090102	29	0520091-290102
10	0520091-100102	30	0520091-300102
11	0520091-110102	31	0520091-310102
12	0520091-120102	32	0520091-320102
13	0520091-130102	33	0520091-330102
14	0520091-140102	34	0520091-340102
15	0520091-150102	35	0520091-350102
16	0520091-160102	36	0520091-360102
17	0520091-170102	37	0520091-370102
18	0520091-180102	38	0520091-380102
19	0520091-190102	39	0520091-390102
20	0520091-200102	40	0520091-400102

2.00mm(0.079") Pitch  
Female Header Connector

0520092

Right Angle, Through Hole

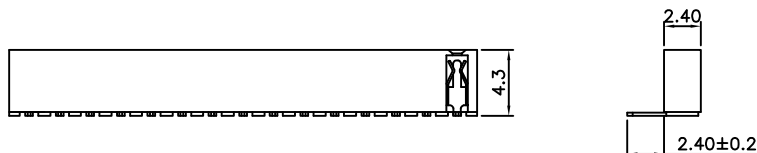
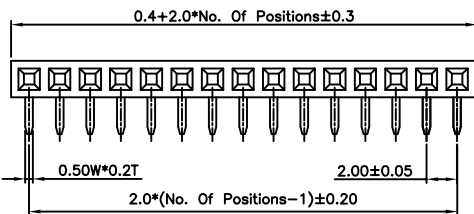

Specifications

Rating

Current Rating:2.0 Amp  
Voltage Rating:150V AC/DC  
Operating Temperature Range:-40~+105°C

Electrical

Contact resistance:20m Ohm Max  
Insulator resistance:1000M ohm min.  
Withstanding Voltage:500V AC/Minute

Material And Finish

Insulator:Nylon 6T UL94V-0 Color:Black  
Contact:Phosphor Bronze  
Plated:Gold Flash Over Nickel

No.of CKTS	Part No.	No.of CKTS	Part No.
		21	0520092-210101
02	0520092-020101	22	0520092-220101
03	0520092-030101	23	0520092-230101
04	0520092-040101	24	0520092-240101
05	0520092-050101	25	0520092-250101
06	0520092-060101	26	0520092-260101
07	0520092-070101	27	0520092-270101
08	0520092-080101	28	0520092-280101
09	0520092-090101	29	0520092-290101
10	0520092-100101	30	0520092-300101
11	0520092-110101	31	0520092-310101
12	0520092-120101	32	0520092-320101
13	0520092-130101	33	0520092-330101
14	0520092-140101	34	0520092-340101
15	0520092-150101	35	0520092-350101
16	0520092-160101	36	0520092-360101
17	0520092-170101	37	0520092-370101
18	0520092-180101	38	0520092-380101
19	0520092-190101	39	0520092-390101
20	0520092-200101	40	0520092-400101

2.00mm(0.079") Pitch  
Female Header Connector

0520098  
Vertical, SMT

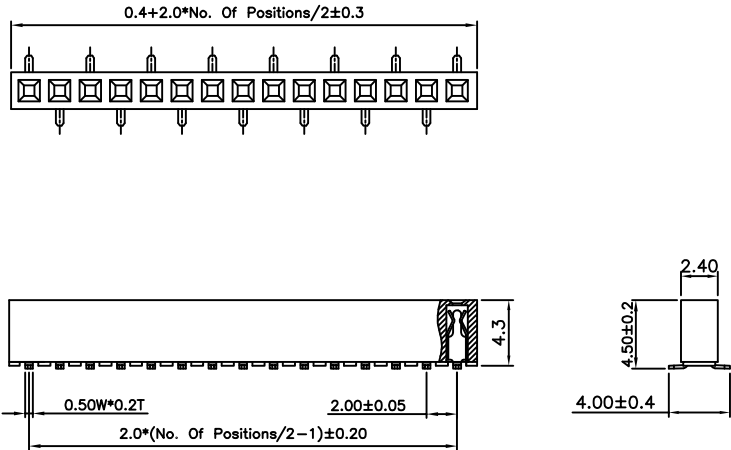

Specifications

Rating

Current Rating:2.0 Amp  
Voltage Rating:150V AC/DC  
Operating Temperature Range:-40~+105°C

Electrical

Contact resistance:20m Ohm Max  
Insulator resistance:1000M ohm min.  
Withstanding Voltage:500V AC/Minute

Material And Finish

Insulator:Nylon 6T UL94V-0 Color:Black  
Contact:Phosphor Bronze  
Plated:Gold Flash Over Nickel

No.of CKTS	Part No.	No.of CKTS	Part No.
		21	0520098-210101
02	0520098-020101	22	0520098-220101
03	0520098-030101	23	0520098-230101
04	0520098-040101	24	0520098-240101
05	0520098-050101	25	0520098-250101
06	0520098-060101	26	0520098-260101
07	0520098-070101	27	0520098-270101
08	0520098-080101	28	0520098-280101
09	0520098-090101	29	0520098-290101
10	0520098-100101	30	0520098-300101
11	0520098-110101	31	0520098-310101
12	0520098-120101	32	0520098-320101
13	0520098-130101	33	0520098-330101
14	0520098-140101	34	0520098-340101
15	0520098-150101	35	0520098-350101
16	0520098-160101	36	0520098-360101
17	0520098-170101	37	0520098-370101
18	0520098-180101	38	0520098-380101
19	0520098-190101	39	0520098-390101
20	0520098-200101	40	0520098-400101

2.00mm(0.079") Pitch  
Female Header Connector

052009A  
Vertical, Through Hole

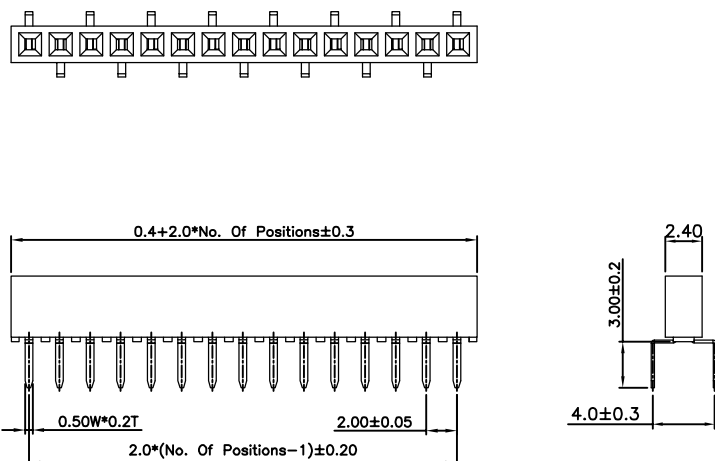

Specifications

Rating

Current Rating:2.0 Amp  
Voltage Rating:150V AC/DC  
Operating Temperature Range:-40~+105°C

Electrical

Contact resistance:20m Ohm Max  
Insulator resistance:1000M ohm min.  
Withstanding Voltage:500V AC/Minute

Material And Finish

Insulator:Nylon 6T UL94V-0 Color:Black  
Contact:Phosphor Bronze  
Plated:Gold Flash Over Nickel

No.of CKTS	Part No.	No.of CKTS	Part No.
		21	052009A-210101
02	052009A-020101	22	052009A-220101
03	052009A-030101	23	052009A-230101
04	052009A-040101	24	052009A-240101
05	052009A-050101	25	052009A-250101
06	052009A-060101	26	052009A-260101
07	052009A-070101	27	052009A-270101
08	052009A-080101	28	052009A-280101
09	052009A-090101	29	052009A-290101
10	052009A-100101	30	052009A-300101
11	052009A-110101	31	052009A-310101
12	052009A-120101	32	052009A-320101
13	052009A-130101	33	052009A-330101
14	052009A-140101	34	052009A-340101
15	052009A-150101	35	052009A-350101
16	052009A-160101	36	052009A-360101
17	052009A-170101	37	052009A-370101
18	052009A-180101	38	052009A-380101
19	052009A-190101	39	052009A-390101
20	052009A-200101	40	052009A-400101

2.00mm(0.079") Pitch  
Female Header Connector

0520101  
Vertical, Through Hole

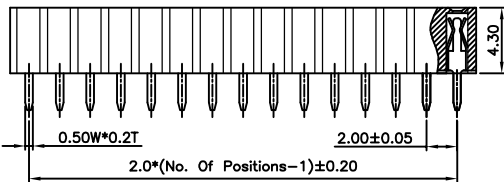
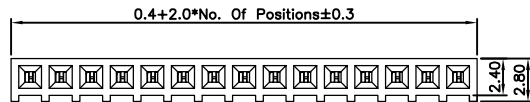
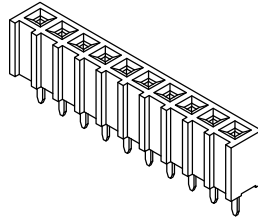

**Specifications**

**Rating**

Current Rating:2.0 Amp  
Voltage Rating:150V AC/DC  
Operating Temperature Range:-40°~+105°C

**Electrical**

Contact resistance:20m Ohm Max  
Insulator resistance:1000M ohm min.  
Withstanding Voltage:500V AC/Minute

**Material And Finish**

Insulator:PBT UL94V-0 Color:Black  
Contact:Phosphor Bronze  
Plated:Gold Flash Over Nickel

No.of CKTS	Part No.	No.of CKTS	Part No.
		21	0520101-210002
02	0520101-020002	22	0520101-220002
03	0520101-030002	23	0520101-230002
04	0520101-040002	24	0520101-240002
05	0520101-050002	25	0520101-250002
06	0520101-060002	26	0520101-260002
07	0520101-070002	27	0520101-270002
08	0520101-080002	28	0520101-280002
09	0520101-090002	29	0520101-290002
10	0520101-100002	30	0520101-300002
11	0520101-110002	31	0520101-310002
12	0520101-120002	32	0520101-320002
13	0520101-130002	33	0520101-330002
14	0520101-140002	34	0520101-340002
15	0520101-150002	35	0520101-350002
16	0520101-160002	36	0520101-360002
17	0520101-170002	37	0520101-370002
18	0520101-180002	38	0520101-380002
19	0520101-190002	39	0520101-390002
20	0520101-200002	40	0520101-400002

2.00mm(0.079") Pitch  
Female Header Connector

0520102  
Right Angle, Through Hole

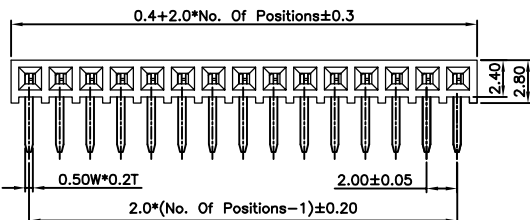

**Specifications**

**Rating**

Current Rating:2.0 Amp  
Voltage Rating:150V AC/DC  
Operating Temperature Range:-40°~+105°C

**Electrical**

Contact resistance:20m Ohm Max  
Insulator resistance:1000M ohm min.  
Withstanding Voltage:500V AC/Minute

**Material And Finish**

Insulator:PBT UL94V-0 Color:Black  
Contact:Phosphor Bronze  
Plated:Gold Flash Over Nickel

No.of CKTS	Part No.	No.of CKTS	Part No.
		21	0520102-210002
02	0520102-020002	22	0520102-220002
03	0520102-030002	23	0520102-230002
04	0520102-040002	24	0520102-240002
05	0520102-050002	25	0520102-250002
06	0520102-060002	26	0520102-260002
07	0520102-070002	27	0520102-270002
08	0520102-080002	28	0520102-280002
09	0520102-090002	29	0520102-290002
10	0520102-100002	30	0520102-300002
11	0520102-110002	31	0520102-310002
12	0520102-120002	32	0520102-320002
13	0520102-130002	33	0520102-330002
14	0520102-140002	34	0520102-340002
15	0520102-150002	35	0520102-350002
16	0520102-160002	36	0520102-360002
17	0520102-170002	37	0520102-370002
18	0520102-180002	38	0520102-380002
19	0520102-190002	39	0520102-390002
20	0520102-200002	40	0520102-400002

2.00mm(0.079") Pitch  
Female Header Connector

0520116  
Vertical, SMT

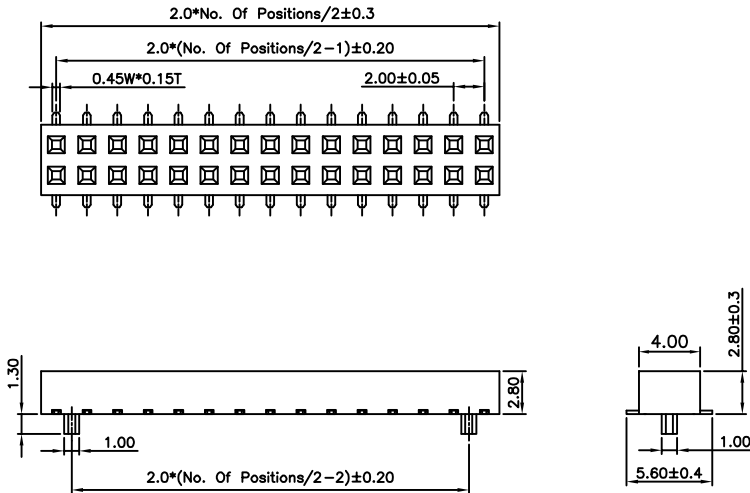

Specifications

Rating

Current Rating:2.0 Amp  
Voltage Rating:150V AC/DC  
Operating Temperature Range:-40°~+105°C

Electrical

Contact resistance:20m Ohm Max  
Insulator resistance:1000M ohm min.  
Withstanding Voltage:500V AC/Minute

Material And Finish

Insulator:Nylon 6T UL94V-0 Color:Black  
Contact:Phosphor Bronze  
Plated:Gold Flash Over Nickel

No. of CKTS	Part No.	No. of CKTS	Part No.
04	0520116-040101	42	0520116-420101
06	0520116-060101	44	0520116-440101
08	0520116-080101	46	0520116-460101
10	0520116-100101	48	0520116-480101
12	0520116-120101	50	0520116-500101
14	0520116-140101	52	0520116-520101
16	0520116-160101	54	0520116-540101
18	0520116-180101	56	0520116-560101
20	0520116-200101	58	0520116-580101
22	0520116-220101	60	0520116-600101
24	0520116-240101	62	0520116-620101
26	0520116-260101	64	0520116-640101
28	0520116-280101	66	0520116-660101
30	0520116-300101	68	0520116-680101
32	0520116-320101	70	0520116-700101
34	0520116-340101	72	0520116-720101
36	0520116-360101	74	0520116-740101
38	0520116-380101	76	0520116-760101
40	0520116-400101	78	0520116-780101
		80	0520116-800101

2.00mm(0.079") Pitch  
Female Header Connector

0520152  
Right Angle, Through Hole

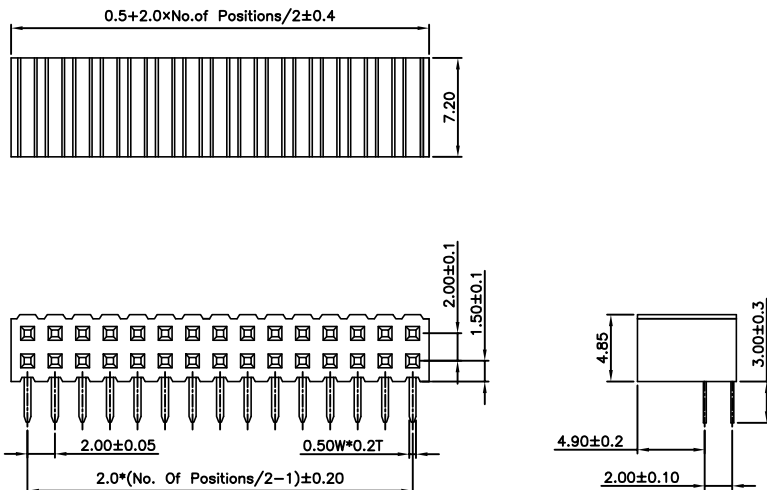

Specifications

Rating

Current Rating:2.0 Amp  
Voltage Rating:150V AC/DC  
Operating Temperature Range:-40°~+105°C

Electrical

Contact resistance:20m Ohm Max  
Insulator resistance:1000M ohm min.  
Withstanding Voltage:500V AC/Minute

Material And Finish

Insulator:Nylon 46 UL94V-0 Color:Black  
Contact:Phosphor Bronze  
Plated:Gold Flash Over Nickel

No. of CKTS	Part No.	No. of CKTS	Part No.
04	0520152-040401	42	0520152-420401
06	0520152-060401	44	0520152-440401
08	0520152-080401	46	0520152-460401
10	0520152-100401	48	0520152-480401
12	0520152-120401	50	0520152-500401
14	0520152-140401	52	0520152-520401
16	0520152-160401	54	0520152-540401
18	0520152-180401	56	0520152-560401
20	0520152-200401	58	0520152-580401
22	0520152-220401	60	0520152-600401
24	0520152-240401	62	0520152-620401
26	0520152-260401	64	0520152-640401
28	0520152-280401	66	0520152-660401
30	0520152-300401	68	0520152-680401
32	0520152-320401	70	0520152-700401
34	0520152-340401	72	0520152-720401
36	0520152-360401	74	0520152-740401
38	0520152-380401	76	0520152-760401
40	0520152-400401	78	0520152-780401
		80	0520152-800401

2.00mm(0.079") Pitch  
Female Header Connector

0520161

Vertical, Through Hole

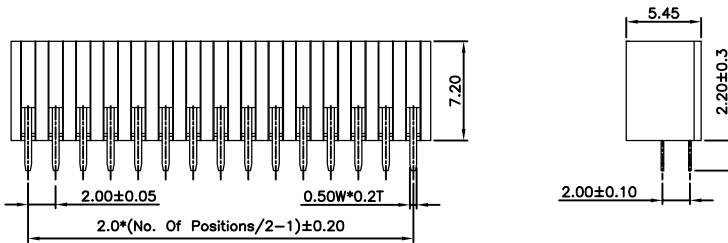
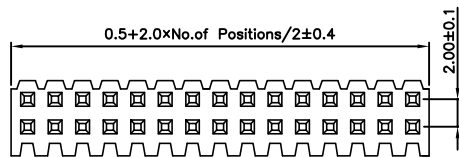

**Specifications**

**Rating**

Current Rating:2.0 Amp  
Voltage Rating:150V AC/DC  
Operating Temperature Range:-40°~+105°C

**Electrical**

Contact resistance:20m Ohm Max  
Insulator resistance:1000M ohm min.  
Withstanding Voltage:500V AC/Minute

**Material And Finish**

Insulator:Nylon 46 UL94V-0 Color:Black  
Contact:Phosphor Bronze  
Plated:Gold Flash Over Nickel

No.of CKTS	Part No.	No.of CKTS	Part No.
04	0520161-040401	42	0520161-420401
06	0520161-060401	44	0520161-440401
08	0520161-080401	46	0520161-460401
10	0520161-100401	48	0520161-480401
12	0520161-120401	50	0520161-500401
14	0520161-140401	52	0520161-520401
16	0520161-160401	54	0520161-540401
18	0520161-180401	56	0520161-560401
20	0520161-200401	58	0520161-580401
22	0520161-220401	60	0520161-600401
24	0520161-240401	62	0520161-620401
26	0520161-260401	64	0520161-640401
28	0520161-280401	66	0520161-660401
30	0520161-300401	68	0520161-680401
32	0520161-320401	70	0520161-700401
34	0520161-340401	72	0520161-720401
36	0520161-360401	74	0520161-740401
38	0520161-380401	76	0520161-760401
40	0520161-400401	78	0520161-780401
		80	0520161-800401

2.00mm(0.079") Pitch  
Female Header Connector

0520162

Right Angle, Through Hole

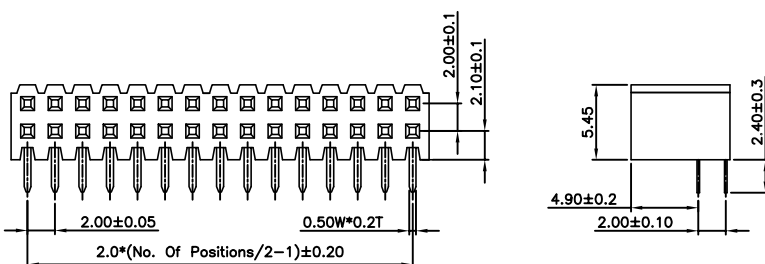
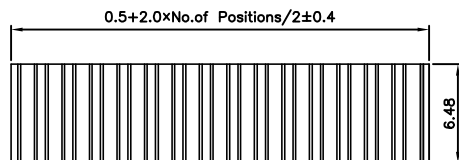

**Specifications**

**Rating**

Current Rating:2.0 Amp  
Voltage Rating:150V AC/DC  
Operating Temperature Range:-40°~+105°C

**Electrical**

Contact resistance:20m Ohm Max  
Insulator resistance:1000M ohm min.  
Withstanding Voltage:500V AC/Minute

**Material And Finish**

Insulator:Nylon 46 UL94V-0 Color:Black  
Contact:Phosphor Bronze  
Plated:Gold Flash Over Nickel

No.of CKTS	Part No.	No.of CKTS	Part No.
04	0520162-040401	42	0520162-420401
06	0520162-060401	44	0520162-440401
08	0520162-080401	46	0520162-460401
10	0520162-100401	48	0520162-480401
12	0520162-120401	50	0520162-500401
14	0520162-140401	52	0520162-520401
16	0520162-160401	54	0520162-540401
18	0520162-180401	56	0520162-560401
20	0520162-200401	58	0520162-580401
22	0520162-220401	60	0520162-600401
24	0520162-240401	62	0520162-620401
26	0520162-260401	64	0520162-640401
28	0520162-280401	66	0520162-660401
30	0520162-300401	68	0520162-680401
32	0520162-320401	70	0520162-700401
34	0520162-340401	72	0520162-720401
36	0520162-360401	74	0520162-740401
38	0520162-380401	76	0520162-760401
40	0520162-400401	78	0520162-780401
		80	0520162-800401

2.00mm(0.079") Pitch  
Female Header Connector

0520122  
Right Angle, Through Hole

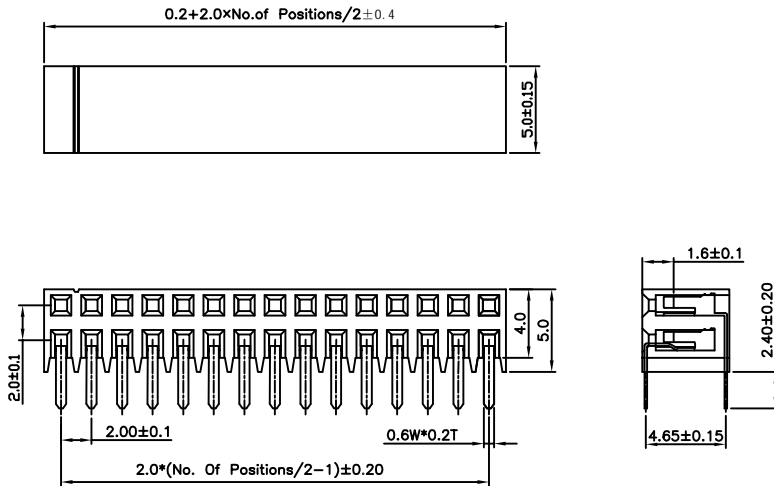

Specifications

Rating

Current Rating:2.0 Amp  
Voltage Rating:150V AC/DC  
Operating Temperature Range:-40~+105°C

Electrical

Contact resistance:20m Ohm Max  
Insulator resistance:1000M ohm min.  
Withstanding Voltage:500V AC/Minute

Material And Finish

Insulator:Nylon 6T UL94V-0 Color:Black  
Contact:Phosphor Bronze  
Plated:Gold Flash Over Nickel

No.of CKTS	Part No.	No.of CKTS	Part No.
04	0520122-040101	42	0520122-420101
06	0520122-060101	44	0520122-440101
08	0520122-080101	46	0520122-460101
10	0520122-100101	48	0520122-480101
12	0520122-120101	50	0520122-500101
14	0520122-140101	52	0520122-520101
16	0520122-160101	54	0520122-540101
18	0520122-180101	56	0520122-560101
20	0520122-200101	58	0520122-580101
22	0520122-220101	60	0520122-600101
24	0520122-240101	62	0520122-620101
26	0520122-260101	64	0520122-640101
28	0520122-280101	66	0520122-660101
30	0520122-300101	68	0520122-680101
32	0520122-320101	70	0520122-700101
34	0520122-340101	72	0520122-720101
36	0520122-360101	74	0520122-740101
38	0520122-380101	76	0520122-760101
40	0520122-400101	78	0520122-780101
		80	0520122-800101

2.00mm(0.079") Pitch  
Female Header Connector

0520124  
Right Angle, SMT

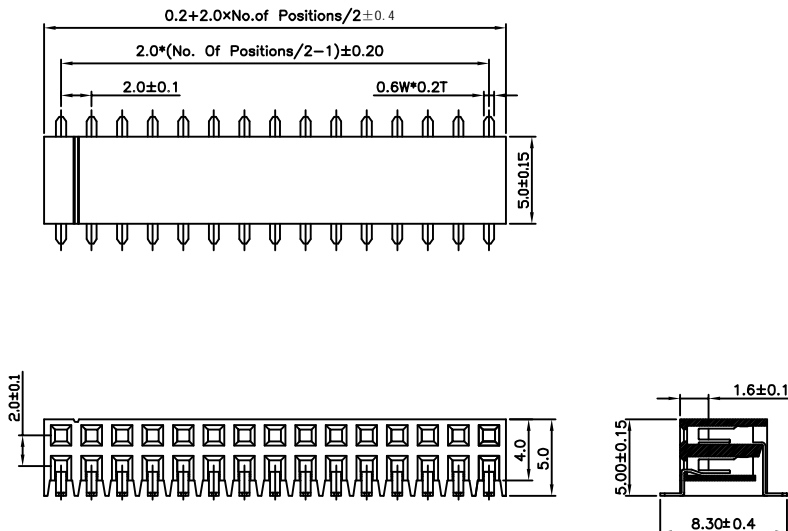

Specifications

Rating

Current Rating:2.0 Amp  
Voltage Rating:150V AC/DC  
Operating Temperature Range:-40~+105°C

Electrical

Contact resistance:20m Ohm Max  
Insulator resistance:1000M ohm min.  
Withstanding Voltage:500V AC/Minute

Material And Finish

Insulator:Nylon 6T UL94V-0 Color:Black  
Contact:Phosphor Bronze  
Plated:Gold Flash Over Nickel

No.of CKTS	Part No.	No.of CKTS	Part No.
04	0520124-040101	42	0520124-420101
06	0520124-060101	44	0520124-440101
08	0520124-080101	46	0520124-460101
10	0520124-100101	48	0520124-480101
12	0520124-120101	50	0520124-500101
14	0520124-140101	52	0520124-520101
16	0520124-160101	54	0520124-540101
18	0520124-180101	56	0520124-560101
20	0520124-200101	58	0520124-580101
22	0520124-220101	60	0520124-600101
24	0520124-240101	62	0520124-620101
26	0520124-260101	64	0520124-640101
28	0520124-280101	66	0520124-660101
30	0520124-300101	68	0520124-680101
32	0520124-320101	70	0520124-700101
34	0520124-340101	72	0520124-720101
36	0520124-360101	74	0520124-740101
38	0520124-380101	76	0520124-760101
40	0520124-400101	78	0520124-780101
		80	0520124-800101

2.00mm(0.079") Pitch  
Female Header Connector

0520132  
Right Angle, Through Hole

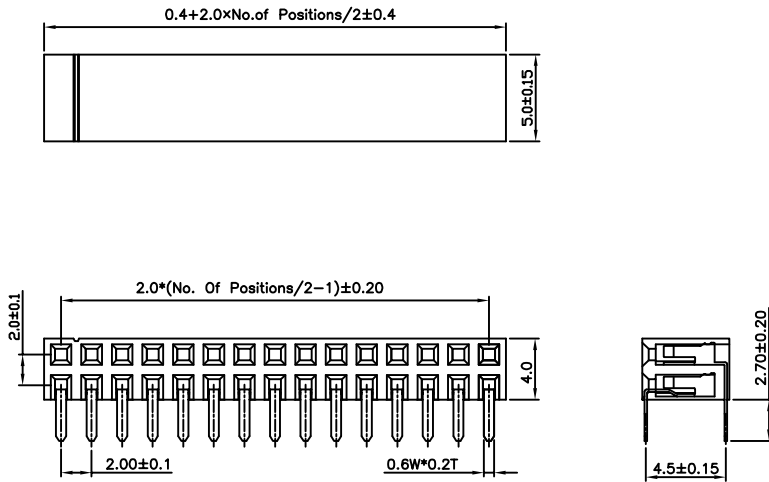

**Specifications**

**Rating**

Current Rating: 2.0 Amp  
Voltage Rating: 150V AC/DC  
Operating Temperature Range:  $-40^{\circ} \sim +105^{\circ}C$

**Electrical**

Contact resistance: 20m Ohm Max  
Insulator resistance: 1000M ohm min.  
Withstanding Voltage: 500V AC/Minute

**Material And Finish**

Insulator: Nylon 6T UL94V-0 Color: Black  
Contact: Phosphor Bronze  
Plated: Gold Flash Over Nickel

No. of CKTS	Part No.	No. of CKTS	Part No.
04	0520132-040101	42	0520132-420101
06	0520132-060101	44	0520132-440101
08	0520132-080101	46	0520132-460101
10	0520132-100101	48	0520132-480101
12	0520132-120101	50	0520132-500101
14	0520132-140101	52	0520132-520101
16	0520132-160101	54	0520132-540101
18	0520132-180101	56	0520132-560101
20	0520132-200101	58	0520132-580101
22	0520132-220101	60	0520132-600101
24	0520132-240101	62	0520132-620101
26	0520132-260101	64	0520132-640101
28	0520132-280101	66	0520132-660101
30	0520132-300101	68	0520132-680101
32	0520132-320101	70	0520132-700101
34	0520132-340101	72	0520132-720101
36	0520132-360101	74	0520132-740101
38	0520132-380101	76	0520132-760101
40	0520132-400101	78	0520132-780101
		80	0520132-800101

2.00mm(0.079") Pitch  
Female Header Connector

0520134  
Right Angle, SMT

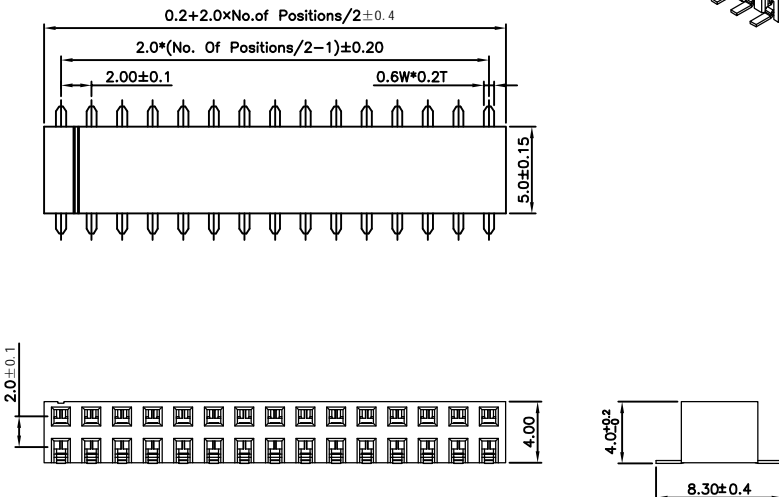
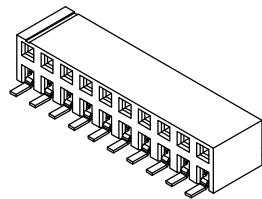

**Specifications**

**Rating**

Current Rating: 2.0 Amp  
Voltage Rating: 150V AC/DC  
Operating Temperature Range:  $-40^{\circ} \sim +105^{\circ}C$

**Electrical**

Contact resistance: 20m Ohm Max  
Insulator resistance: 1000M ohm min.  
Withstanding Voltage: 500V AC/Minute

**Material And Finish**

Insulator: Nylon 6T UL94V-0 Color: Black  
Contact: Phosphor Bronze  
Plated: Gold Flash Over Nickel

No. of CKTS	Part No.	No. of CKTS	Part No.
04	0520134-040101	42	0520134-420101
06	0520134-060101	44	0520134-440101
08	0520134-080101	46	0520134-460101
10	0520134-100101	48	0520134-480101
12	0520134-120101	50	0520134-500101
14	0520134-140101	52	0520134-520101
16	0520134-160101	54	0520134-540101
18	0520134-180101	56	0520134-560101
20	0520134-200101	58	0520134-580101
22	0520134-220101	60	0520134-600101
24	0520134-240101	62	0520134-620101
26	0520134-260101	64	0520134-640101
28	0520134-280101	66	0520134-660101
30	0520134-300101	68	0520134-680101
32	0520134-320101	70	0520134-700101
34	0520134-340101	72	0520134-720101
36	0520134-360101	74	0520134-740101
38	0520134-380101	76	0520134-760101
40	0520134-400101	78	0520134-780101
		80	0520134-800101

2.00mm(0.079") Pitch  
Female Header Connector

0520141  
Vertical, Through Hole

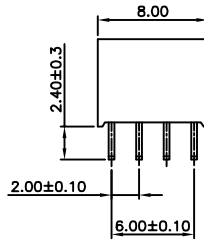
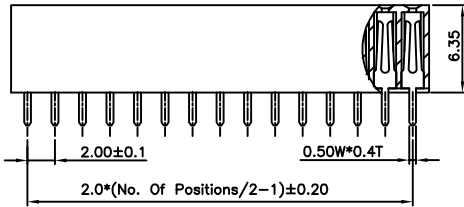
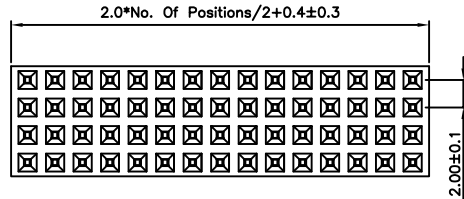
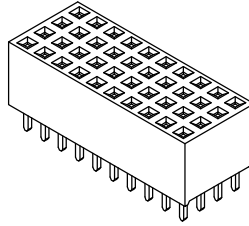

Specifications

Rating

Current Rating:2.0 Amp  
Voltage Rating:150V AC/DC  
Operating Temperature Range:-40°~+105°C

Electrical

Contact resistance:20m Ohm Max  
Insulator resistance:1000M ohm min.  
Withstanding Voltage:500V AC/Minute

Material And Finish

Insulator:Nylon 6T UL94V-0 Color:Black  
Contact:Phosphor Bronze  
Plated:Gold Flash Over Nickel

No.of CKTS	Part No.	No.of CKTS	Part No.
		68	0520141-680102
16	0520141-160102	72	0520141-720102
20	0520141-200102	76	0520141-760102
24	0520141-240102	80	0520141-800102
28	0520141-280102	84	0520141-840102
32	0520141-320102	88	0520141-880102
36	0520141-360102	92	0520141-920102
40	0520141-400102	96	0520141-960102
44	0520141-440102	100	0520141-1000102
48	0520141-480102	104	0520141-1040102
52	0520141-520102	108	0520141-1080102
56	0520141-560102	112	0520141-1120102
60	0520141-600102	116	0520141-1160102
64	0520141-640102	120	0520141-1200102

2.00mm(0.079") Pitch  
Female Header Connector

05201411  
Vertical, Through Hole

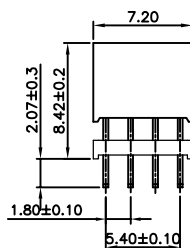
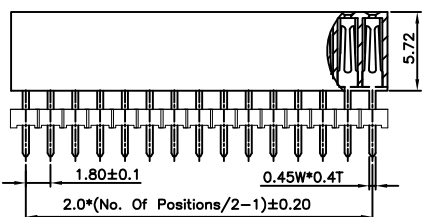
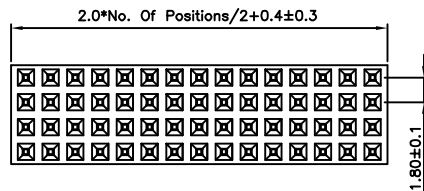
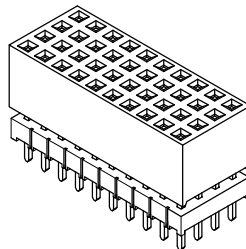

Specifications

Rating

Current Rating:2.0 Amp  
Voltage Rating:150V AC/DC  
Operating Temperature Range:-40°~+105°C

Electrical

Contact resistance:20m Ohm Max  
Insulator resistance:1000M ohm min.  
Withstanding Voltage:500V AC/Minute

Material And Finish

Insulator:Nylon 6T UL94V-0 Color:Black  
Contact:Phosphor Bronze  
Plated:Gold Flash Over Nickel

No.of CKTS	Part No.	No.of CKTS	Part No.
		68	05201411-680102
16	05201411-160102	72	05201411-720102
20	05201411-200102	76	05201411-760102
24	05201411-240102	80	05201411-800102
28	05201411-280102	84	05201411-840102
32	05201411-320102	88	05201411-880102
36	05201411-360102	92	05201411-920102
40	05201411-400102	96	05201411-960102
44	05201411-440102	100	05201411-1000102
48	05201411-480102	104	05201411-1040102
52	05201411-520102	108	05201411-1080102
56	05201411-560102	112	05201411-1120102
60	05201411-600102	116	05201411-1160102
64	05201411-640102	120	05201411-1200102



2.54mm(0.10") Pitch  
Female Header Connector

0525022  
Right Angle, Through Hole

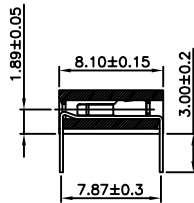
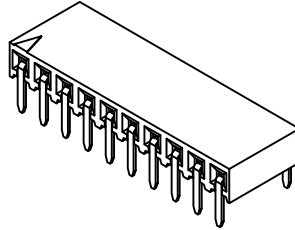
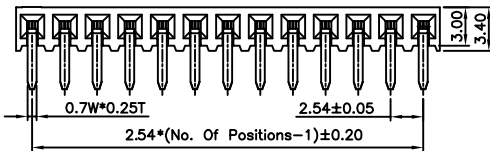
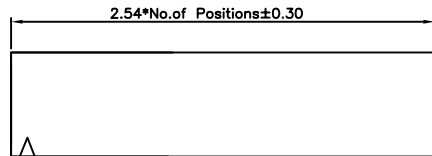

Specifications

Rating

Current Rating:3.0 Amp  
Voltage Rating:250V AC/DC  
Operating Temperature Range:-40°~+105°C

Electrical

Contact resistance:20m Ohm Max  
Insulator resistance:1000M ohm min.  
Withstanding Voltage:500V AC/Minute

Material And Finish

Insulator:Nylon 6T UL94V-0 Color:Black  
Contact:Phosphor Bronze  
Plated:Gold Flash Over Nickel

No.of CKTS	Part No.	No.of CKTS	Part No.
		21	0525022-210101
02	0525022-020101	22	0525022-220101
03	0525022-030101	23	0525022-230101
04	0525022-040101	24	0525022-240101
05	0525022-050101	25	0525022-250101
06	0525022-060101	26	0525022-260101
07	0525022-070101	27	0525022-270101
08	0525022-080101	28	0525022-280101
09	0525022-090101	29	0525022-290101
10	0525022-100101	30	0525022-300101
11	0525022-110101	31	0525022-310101
12	0525022-120101	32	0525022-320101
13	0525022-130101	33	0525022-330101
14	0525022-140101	34	0525022-340101
15	0525022-150101	35	0525022-350101
16	0525022-160101	36	0525022-360101
17	0525022-170101	37	0525022-370101
18	0525022-180101	38	0525022-380101
19	0525022-190101	39	0525022-390101
20	0525022-200101	40	0525022-400101

2.54mm(0.10") Pitch  
Female Header Connector

0525024  
Right Angle, SMT

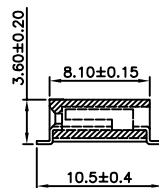
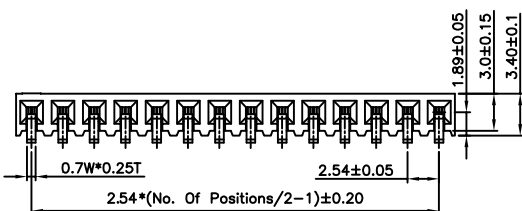
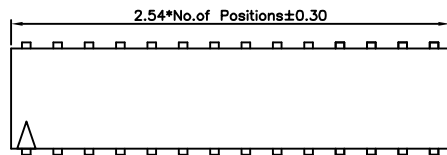

Specifications

Rating

Current Rating:3.0 Amp  
Voltage Rating:250V AC/DC  
Operating Temperature Range:-40°~+105°C

Electrical

Contact resistance:20m Ohm Max  
Insulator resistance:1000M ohm min.  
Withstanding Voltage:500V AC/Minute

Material And Finish

Insulator:Nylon 6T UL94V-0 Color:Black  
Contact:Phosphor Bronze  
Plated:Gold Flash Over Nickel

No.of CKTS	Part No.	No.of CKTS	Part No.
		21	0525024-210101
02	0525024-020101	22	0525024-220101
03	0525024-030101	23	0525024-230101
04	0525024-040101	24	0525024-240101
05	0525024-050101	25	0525024-250101
06	0525024-060101	26	0525024-260101
07	0525024-070101	27	0525024-270101
08	0525024-080101	28	0525024-280101
09	0525024-090101	29	0525024-290101
10	0525024-100101	30	0525024-300101
11	0525024-110101	31	0525024-310101
12	0525024-120101	32	0525024-320101
13	0525024-130101	33	0525024-330101
14	0525024-140101	34	0525024-340101
15	0525024-150101	35	0525024-350101
16	0525024-160101	36	0525024-360101
17	0525024-170101	37	0525024-370101
18	0525024-180101	38	0525024-380101
19	0525024-190101	39	0525024-390101
20	0525024-200101	40	0525024-400101

2.54mm(0.10") Pitch  
Female Header Connector

0525032  
Right Angle, Through Hole

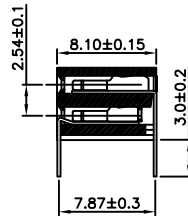
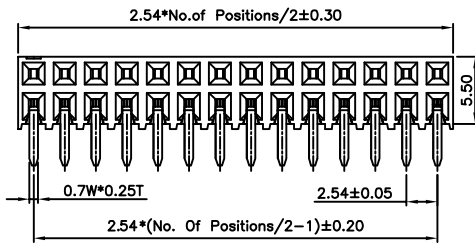
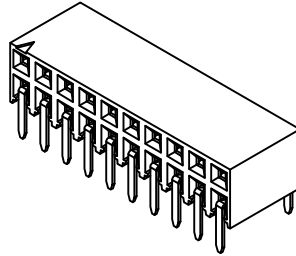

Specifications

Rating

Current Rating:3.0 Amp  
Voltage Rating:250V AC/DC  
Operating Temperature Range:-40°~+105°C

Electrical

Contact resistance:20m Ohm Max  
Insulator resistance:1000M ohm min.  
Withstanding Voltage:500V AC/Minute

Material And Finish

Insulator:Nylon 6T UL94V-0 Color:Black  
Contact:Phosphor Bronze  
Plated:Gold Flash Over Nickel

No. of CKTS	Part No.	No. of CKTS	Part No.
		21	0525032-210101
02	0525032-020101	22	0525032-220101
03	0525032-030101	23	0525032-230101
04	0525032-040101	24	0525032-240101
05	0525032-050101	25	0525032-250101
06	0525032-060101	26	0525032-260101
07	0525032-070101	27	0525032-270101
08	0525032-080101	28	0525032-280101
09	0525032-090101	29	0525032-290101
10	0525032-100101	30	0525032-300101
11	0525032-110101	31	0525032-310101
12	0525032-120101	32	0525032-320101
13	0525032-130101	33	0525032-330101
14	0525032-140101	34	0525032-340101
15	0525032-150101	35	0525032-350101
16	0525032-160101	36	0525032-360101
17	0525032-170101	37	0525032-370101
18	0525032-180101	38	0525032-380101
19	0525032-190101	39	0525032-390101
20	0525032-200101	40	0525032-400101

2.54mm(0.10") Pitch  
Female Header Connector

0525034  
Right Angle, SMT

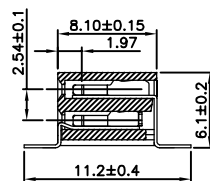
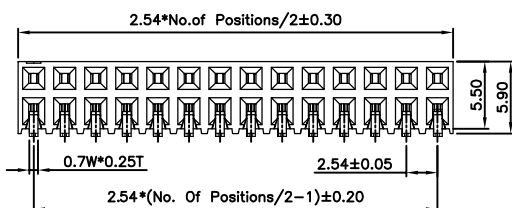
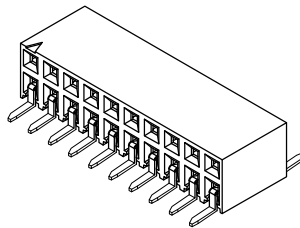
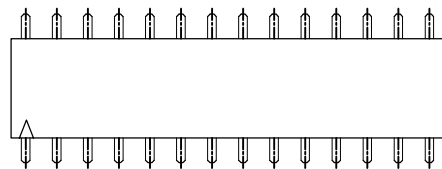

Specifications

Rating

Current Rating:3.0 Amp  
Voltage Rating:250V AC/DC  
Operating Temperature Range:-40°~+105°C

Electrical

Contact resistance:20m Ohm Max  
Insulator resistance:1000M ohm min.  
Withstanding Voltage:500V AC/Minute

Material And Finish

Insulator:Nylon 6T UL94V-0 Color:Black  
Contact:Phosphor Bronze  
Plated:Gold Flash Over Nickel

No. of CKTS	Part No.	No. of CKTS	Part No.
		21	0525034-210101
02	0525034-020101	22	0525034-220101
03	0525034-030101	23	0525034-230101
04	0525034-040101	24	0525034-240101
05	0525034-050101	25	0525034-250101
06	0525034-060101	26	0525034-260101
07	0525034-070101	27	0525034-270101
08	0525034-080101	28	0525034-280101
09	0525034-090101	29	0525034-290101
10	0525034-100101	30	0525034-300101
11	0525034-110101	31	0525034-310101
12	0525034-120101	32	0525034-320101
13	0525034-130101	33	0525034-330101
14	0525034-140101	34	0525034-340101
15	0525034-150101	35	0525034-350101
16	0525034-160101	36	0525034-360101
17	0525034-170101	37	0525034-370101
18	0525034-180101	38	0525034-380101
19	0525034-190101	39	0525034-390101
20	0525034-200101	40	0525034-400101

2.54mm(0.10") Pitch  
Female Header Connector

0525042  
Right Angle, Through Hole

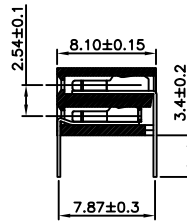
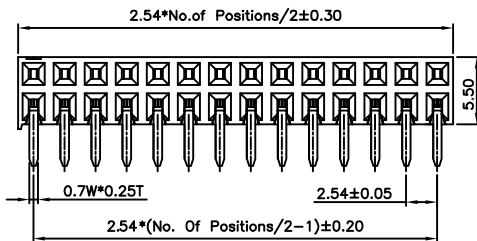
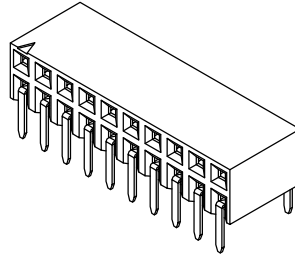

Specifications

Rating

Current Rating:3.0 Amp  
Voltage Rating:250V AC/DC  
Operating Temperature Range:-40°~+105°C

Electrical

Contact resistance:20m Ohm Max  
Insulator resistance:1000M ohm min.  
Withstanding Voltage:500V AC/Minute

Material And Finish

Insulator:Nylon 6T UL94V-0 Color:Black  
Contact:Phosphor Bronze  
Plated:Gold Flash Over Nickel

No.of CKTS	Part No.	No.of CKTS	Part No.
		21	0525042-210101
02	0525042-020101	22	0525042-220101
03	0525042-030101	23	0525042-230101
04	0525042-040101	24	0525042-240101
05	0525042-050101	25	0525042-250101
06	0525042-060101	26	0525042-260101
07	0525042-070101	27	0525042-270101
08	0525042-080101	28	0525042-280101
09	0525042-090101	29	0525042-290101
10	0525042-100101	30	0525042-300101
11	0525042-110101	31	0525042-310101
12	0525042-120101	32	0525042-320101
13	0525042-130101	33	0525042-330101
14	0525042-140101	34	0525042-340101
15	0525042-150101	35	0525042-350101
16	0525042-160101	36	0525042-360101
17	0525042-170101	37	0525042-370101
18	0525042-180101	38	0525042-380101
19	0525042-190101	39	0525042-390101
20	0525042-200101	40	0525042-400101

2.54mm(0.10") Pitch  
Female Header Connector

0525044  
Right Angle, SMT

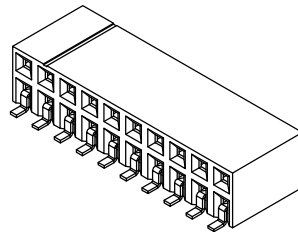
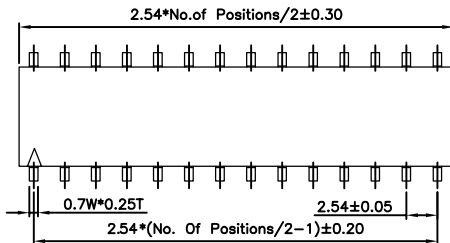

Specifications

Rating

Current Rating:3.0 Amp  
Voltage Rating:250V AC/DC  
Operating Temperature Range:-40°~+105°C

Electrical

Contact resistance:20m Ohm Max  
Insulator resistance:1000M ohm min.  
Withstanding Voltage:500V AC/Minute

Material And Finish

Insulator:Nylon 6T UL94V-0 Color:Black  
Contact:Phosphor Bronze  
Plated:Gold Flash Over Nickel

No.of CKTS	Part No.	No.of CKTS	Part No.
		21	0525044-210101
02	0525044-020101	22	0525044-220101
03	0525044-030101	23	0525044-230101
04	0525044-040101	24	0525044-240101
05	0525044-050101	25	0525044-250101
06	0525044-060101	26	0525044-260101
07	0525044-070101	27	0525044-270101
08	0525044-080101	28	0525044-280101
09	0525044-090101	29	0525044-290101
10	0525044-100101	30	0525044-300101
11	0525044-110101	31	0525044-310101
12	0525044-120101	32	0525044-320101
13	0525044-130101	33	0525044-330101
14	0525044-140101	34	0525044-340101
15	0525044-150101	35	0525044-350101
16	0525044-160101	36	0525044-360101
17	0525044-170101	37	0525044-370101
18	0525044-180101	38	0525044-380101
19	0525044-190101	39	0525044-390101
20	0525044-200101	40	0525044-400101

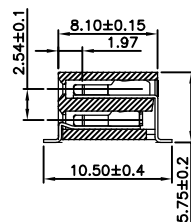
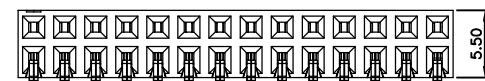

2.54mm(0.10") Pitch  
Female Header Connector

0525051  
Vertical, Through Hole

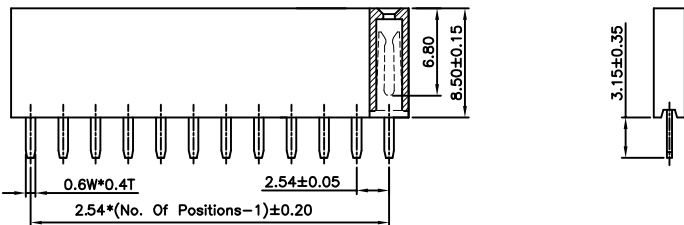
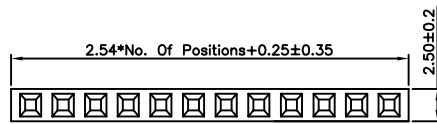

Specifications

Rating

Current Rating:3.0 Amp  
Voltage Rating:250V AC/DC  
Operating Temperature Range:-40°~+105°C

Electrical

Contact resistance:20m Ohm Max  
Insulator resistance:1000M ohm min.  
Withstanding Voltage:500V AC/Minute

Material And Finish

Insulator:PBT UL94V-0 Color:Black  
Contact:Phosphor Bronze  
Plated:Gold Flash Over Nickel

No.of CKTS	Part No.	No.of CKTS	Part No.
		21	0525051-210002
02	0525051-020002	22	0525051-220002
03	0525051-030002	23	0525051-230002
04	0525051-040002	24	0525051-240002
05	0525051-050002	25	0525051-250002
06	0525051-060002	26	0525051-260002
07	0525051-070002	27	0525051-270002
08	0525051-080002	28	0525051-280002
09	0525051-090002	29	0525051-290002
10	0525051-100002	30	0525051-300002
11	0525051-110002	31	0525051-310002
12	0525051-120002	32	0525051-320002
13	0525051-130002	33	0525051-330002
14	0525051-140002	34	0525051-340002
15	0525051-150002	35	0525051-350002
16	0525051-160002	36	0525051-360002
17	0525051-170002	37	0525051-370002
18	0525051-180002	38	0525051-380002
19	0525051-190002	39	0525051-390002
20	0525051-200002	40	0525051-400002

2.54mm(0.10") Pitch  
Female Header Connector

05250511  
Vertical, Through Hole

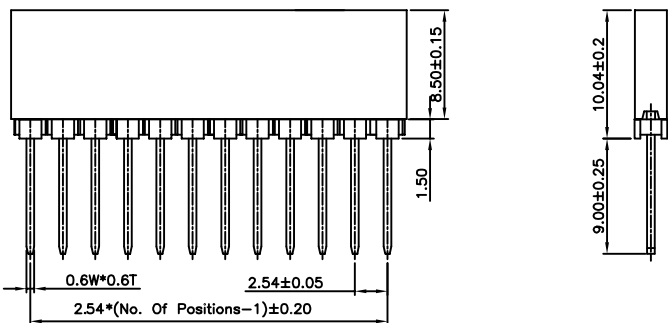
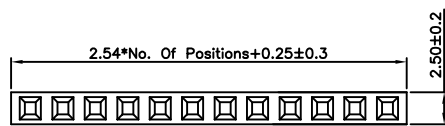

Specifications

Rating

Current Rating:3.0 Amp  
Voltage Rating:250V AC/DC  
Operating Temperature Range:-40°~+105°C

Electrical

Contact resistance:20m Ohm Max  
Insulator resistance:1000M ohm min.  
Withstanding Voltage:500V AC/Minute

Material And Finish

Insulator:PBT UL94V-0 Color:Black  
Contact:Phosphor Bronze  
Plated:Gold Flash Over Nickel

No.of CKTS	Part No.	No.of CKTS	Part No.
		21	05250511-210001
02	05250511-020001	22	05250511-220001
03	05250511-030001	23	05250511-230001
04	05250511-040001	24	05250511-240001
05	05250511-050001	25	05250511-250001
06	05250511-060001	26	05250511-260001
07	05250511-070001	27	05250511-270001
08	05250511-080001	28	05250511-280001
09	05250511-090001	29	05250511-290001
10	05250511-100001	30	05250511-300001
11	05250511-110001	31	05250511-310001
12	05250511-120001	32	05250511-320001
13	05250511-130001	33	05250511-330001
14	05250511-140001	34	05250511-340001
15	05250511-150001	35	05250511-350001
16	05250511-160001	36	05250511-360001
17	05250511-170001	37	05250511-370001
18	05250511-180001	38	05250511-380001
19	05250511-190001	39	05250511-390001
20	05250511-200001	40	05250511-400001

2.54mm(0.10") Pitch  
Female Header Connector

0525052  
Right Angle, Through Hole

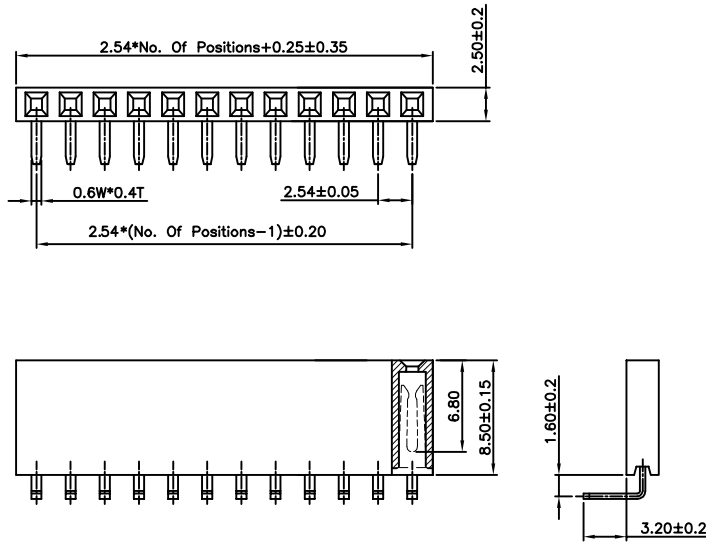

Specifications

Rating

Current Rating:3.0 Amp  
Voltage Rating:250V AC/DC  
Operating Temperature Range:-40°~+105°C

Electrical

Contact resistance:20m Ohm Max  
Insulator resistance:1000M ohm min.  
Withstanding Voltage:500V AC/Minute

Material And Finish

Insulator:PBT UL94V-0 Color:Black  
Contact:Phosphor Bronze  
Plated:Gold Flash Over Nickel

No.of CKTS	Part No.	No.of CKTS	Part No.
		21	0525052-210002
02	0525052-020002	22	0525052-220002
03	0525052-030002	23	0525052-230002
04	0525052-040002	24	0525052-240002
05	0525052-050002	25	0525052-250002
06	0525052-060002	26	0525052-260002
07	0525052-070002	27	0525052-270002
08	0525052-080002	28	0525052-280002
09	0525052-090002	29	0525052-290002
10	0525052-100002	30	0525052-300002
11	0525052-110002	31	0525052-310002
12	0525052-120002	32	0525052-320002
13	0525052-130002	33	0525052-330002
14	0525052-140002	34	0525052-340002
15	0525052-150002	35	0525052-350002
16	0525052-160002	36	0525052-360002
17	0525052-170002	37	0525052-370002
18	0525052-180002	38	0525052-380002
19	0525052-190002	39	0525052-390002
20	0525052-200002	40	0525052-400002

2.54mm(0.10") Pitch  
Female Header Connector

05250512  
Vertical, Through Hole

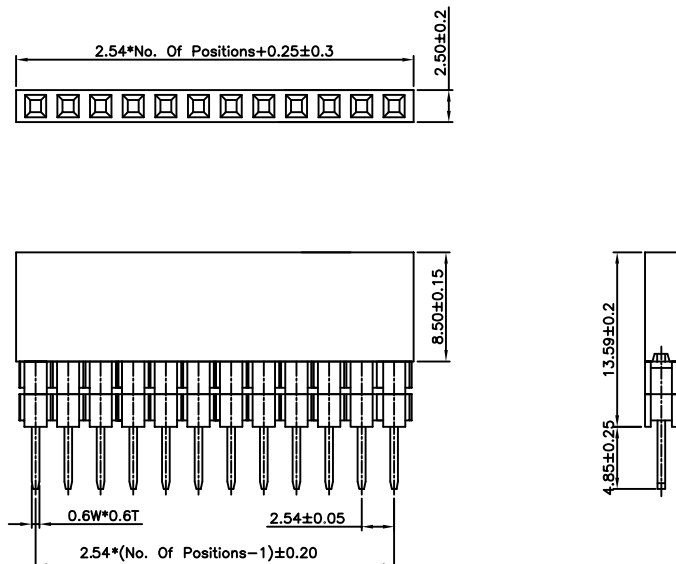

Specifications

Rating

Current Rating:3.0 Amp  
Voltage Rating:250V AC/DC  
Operating Temperature Range:-40°~+105°C

Electrical

Contact resistance:20m Ohm Max  
Insulator resistance:1000M ohm min.  
Withstanding Voltage:500V AC/Minute

Material And Finish

Insulator:PBT UL94V-0 Color:Black  
Contact:Phosphor Bronze  
Plated:Gold Flash Over Nickel

No.of CKTS	Part No.	No.of CKTS	Part No.
		21	05250512-210001
02	05250512-020001	22	05250512-220001
03	05250512-030001	23	05250512-230001
04	05250512-040001	24	05250512-240001
05	05250512-050001	25	05250512-250001
06	05250512-060001	26	05250512-260001
07	05250512-070001	27	05250512-270001
08	05250512-080001	28	05250512-280001
09	05250512-090001	29	05250512-290001
10	05250512-100001	30	05250512-300001
11	05250512-110001	31	05250512-310001
12	05250512-120001	32	05250512-320001
13	05250512-130001	33	05250512-330001
14	05250512-140001	34	05250512-340001
15	05250512-150001	35	05250512-350001
16	05250512-160001	36	05250512-360001
17	05250512-170001	37	05250512-370001
18	05250512-180001	38	05250512-380001
19	05250512-190001	39	05250512-390001
20	05250512-200001	40	05250512-400001

2.54mm(0.10") Pitch  
Female Header Connector

0525065  
Vertical, SMT

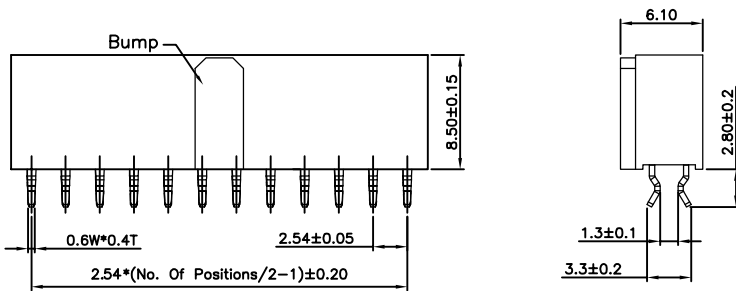
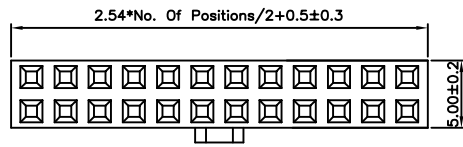

Specifications

Rating

Current Rating:3.0 Amp  
Voltage Rating:250V AC/DC  
Operating Temperature Range:-40°~+105°C

Electrical

Contact resistance:20m Ohm Max  
Insulator resistance:1000M ohm min.  
Withstanding Voltage:500V AC/Minute

Material And Finish

Insulator:Nylon 6T UL94V-0 Color:Black  
Contact:Phosphor Bronze  
Plated:Gold Flash Over Nickel

No.of CKTS	Part No.	No.of CKTS	Part No.
04	0525065-040102	42	0525065-420102
06	0525065-060102	44	0525065-440102
08	0525065-080102	46	0525065-460102
10	0525065-100102	48	0525065-480102
12	0525065-120102	50	0525065-500102
14	0525065-140102	52	0525065-520102
16	0525065-160102	54	0525065-540102
18	0525065-180102	56	0525065-560102
20	0525065-200102	58	0525065-580102
22	0525065-220102	60	0525065-600102
24	0525065-240102	62	0525065-620102
26	0525065-260102	64	0525065-640102
28	0525065-280102	66	0525065-660102
30	0525065-300102	68	0525065-680102
32	0525065-320102	70	0525065-700102
34	0525065-340102	72	0525065-720102
36	0525065-360102	74	0525065-740102
38	0525065-380102	76	0525065-760102
40	0525065-400102	78	0525065-780102
		80	0525065-800102

2.54mm(0.10") Pitch  
Female Header Connector

0525071  
Vertical, Through Hole

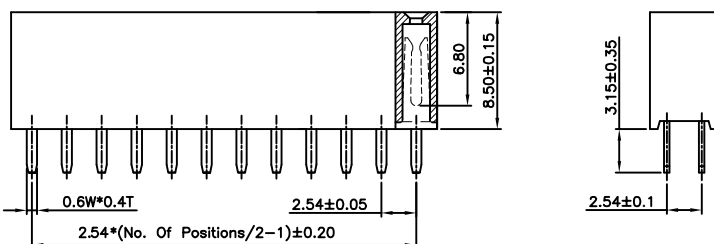
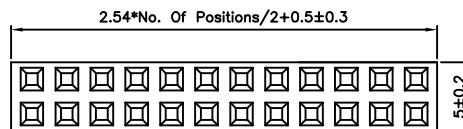

Specifications

Rating

Current Rating:3.0 Amp  
Voltage Rating:250V AC/DC  
Operating Temperature Range:-40°~+105°C

Electrical

Contact resistance:20m Ohm Max  
Insulator resistance:1000M ohm min.  
Withstanding Voltage:500V AC/Minute

Material And Finish

Insulator:PBT UL94V-0 Color:Black  
Contact:Phosphor Bronze  
Plated:Gold Flash Over Nickel

No.of CKTS	Part No.	No.of CKTS	Part No.
04	0525071-040002	42	0525071-420002
06	0525071-060002	44	0525071-440002
08	0525071-080002	46	0525071-460002
10	0525071-100002	48	0525071-480002
12	0525071-120002	50	0525071-500002
14	0525071-140002	52	0525071-520002
16	0525071-160002	54	0525071-540002
18	0525071-180002	56	0525071-560002
20	0525071-200002	58	0525071-580002
22	0525071-220002	60	0525071-600002
24	0525071-240002	62	0525071-620002
26	0525071-260002	64	0525071-640002
28	0525071-280002	66	0525071-660002
30	0525071-300002	68	0525071-680002
32	0525071-320002	70	0525071-700002
34	0525071-340002	72	0525071-720002
36	0525071-360002	74	0525071-740002
38	0525071-380002	76	0525071-760002
40	0525071-400002	78	0525071-780002
		80	0525071-800002

2.54mm(0.10") Pitch  
Female Header Connector

0525072  
Right Angle, Through Hole

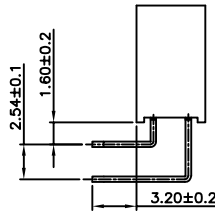
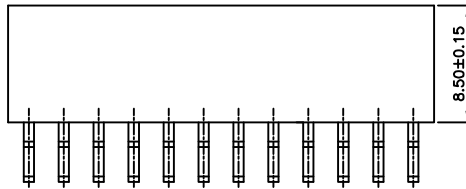
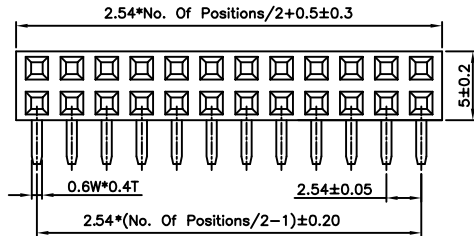

**Specifications**

**Rating**

Current Rating:3.0 Amp  
Voltage Rating:250V AC/DC  
Operating Temperature Range:-40~+105°C

**Electrical**

Contact resistance:20m Ohm Max  
Insulator resistance:1000M ohm min.  
Withstanding Voltage:500V AC/Minute

**Material And Finish**

Insulator:PBT UL94V-0 Color:Black  
Contact:Phosphor Bronze  
Plated:Gold Flash Over Nickel

No.of CKTS	Part No.	No.of CKTS	Part No.
04	0525072-040002	42	0525072-420002
06	0525072-060002	44	0525072-440002
08	0525072-080002	46	0525072-460002
10	0525072-100002	48	0525072-480002
12	0525072-120002	50	0525072-500002
14	0525072-140002	52	0525072-520002
16	0525072-160002	54	0525072-540002
18	0525072-180002	56	0525072-560002
20	0525072-200002	58	0525072-580002
22	0525072-220002	60	0525072-600002
24	0525072-240002	62	0525072-620002
26	0525072-260002	64	0525072-640002
28	0525072-280002	66	0525072-660002
30	0525072-300002	68	0525072-680002
32	0525072-320002	70	0525072-700002
34	0525072-340002	72	0525072-720002
36	0525072-360002	74	0525072-740002
38	0525072-380002	76	0525072-760002
40	0525072-400002	78	0525072-780002
		80	0525072-800002

2.54mm(0.10") Pitch  
Female Header Connector

05250712  
Vertical, Through Hole

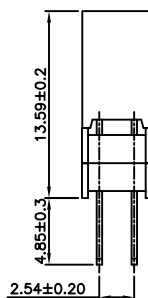
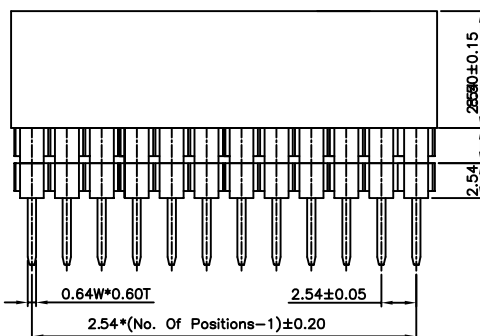
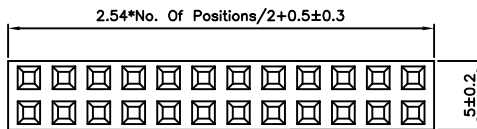

**Specifications**

**Rating**

Current Rating:3.0 Amp  
Voltage Rating:250V AC/DC  
Operating Temperature Range:-40~+105°C

**Electrical**

Contact resistance:20m Ohm Max  
Insulator resistance:1000M ohm min.  
Withstanding Voltage:500V AC/Minute

**Material And Finish**

Insulator:PBT UL94V-0 Color:Black  
Contact:Phosphor Bronze  
Plated:Gold Flash Over Nickel

No.of CKTS	Part No.	No.of CKTS	Part No.
04	05250712-040000	42	05250712-420000
06	05250712-060000	44	05250712-440000
08	05250712-080000	46	05250712-460000
10	05250712-100000	48	05250712-480000
12	05250712-120000	50	05250712-500000
14	05250712-140000	52	05250712-520000
16	05250712-160000	54	05250712-540000
18	05250712-180000	56	05250712-560000
20	05250712-200000	58	05250712-580000
22	05250712-220000	60	05250712-600000
24	05250712-240000	62	05250712-620000
26	05250712-260000	64	05250712-640000
28	05250712-280000	66	05250712-660000
30	05250712-300000	68	05250712-680000
32	05250712-320000	70	05250712-700000
34	05250712-340000	72	05250712-720000
36	05250712-360000	74	05250712-740000
38	05250712-380000	76	05250712-760000
40	05250712-400000	78	05250712-780000
		80	05250712-800000

2.54mm(0.10") Pitch  
Female Header Connector

0525081

Vertical, Through Hole

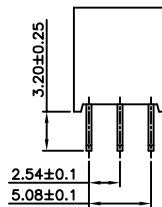
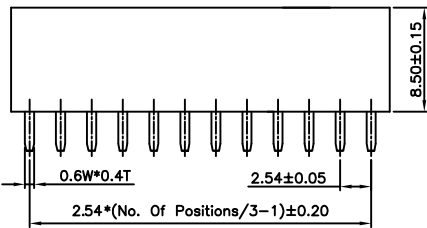
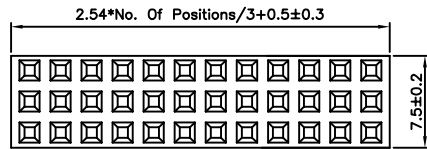

Specifications

Rating

Current Rating:3.0 Amp  
Voltage Rating:250V AC/DC  
Operating Temperature Range:-40~+105°C

Electrical

Contact resistance:20m Ohm Max  
Insulator resistance:1000M ohm min.  
Withstanding Voltage:500V AC/Minute

Material And Finish

Insulator:PBT UL94V-0 Color:Black  
Contact:Phosphor Bronze  
Plated:Gold Flash Over Nickel

No.of CKTS	Part No.	No.of CKTS	Part No.
09	0525081-090002	54	0525081-540002
12	0525081-120002	57	0525081-570002
15	0525081-150002	60	0525081-600002
18	0525081-180002	63	0525081-630002
21	0525081-210002	66	0525081-660002
24	0525081-240002	69	0525081-690002
27	0525081-270002	72	0525081-720002
30	0525081-300002	75	0525081-750002
33	0525081-330002	78	0525081-780002
36	0525081-360002	81	0525081-810002
39	0525081-390002	84	0525081-840002
42	0525081-420002	87	0525081-870002
45	0525081-450002	90	0525081-900002
48	0525081-480002	93	0525081-930002
51	0525081-510002	96	0525081-960002

2.54mm(0.10") Pitch  
Female Header Connector

0525082

Right Angle, Through Hole

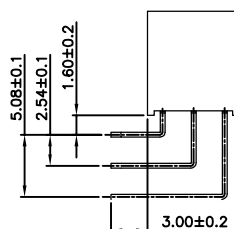
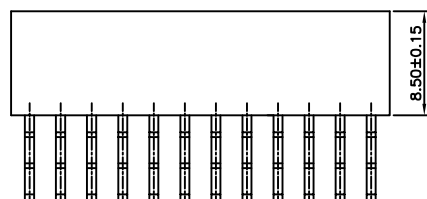
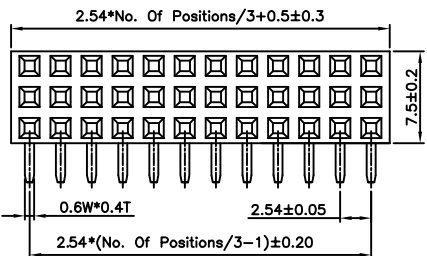

Specifications

Rating

Current Rating:3.0 Amp  
Voltage Rating:250V AC/DC  
Operating Temperature Range:-40~+105°C

Electrical

Contact resistance:20m Ohm Max  
Insulator resistance:1000M ohm min.  
Withstanding Voltage:500V AC/Minute

Material And Finish

Insulator:PBT UL94V-0 Color:Black  
Contact:Phosphor Bronze  
Plated:Gold Flash Over Nickel

No.of CKTS	Part No.	No.of CKTS	Part No.
09	0525082-090000	54	0525082-540000
12	0525082-120000	57	0525082-570000
15	0525082-150000	60	0525082-600000
18	0525082-180000	63	0525082-630000
21	0525082-210000	66	0525082-660000
24	0525082-240000	69	0525082-690000
27	0525082-270000	72	0525082-720000
30	0525082-300000	75	0525082-750000
33	0525082-330000	78	0525082-780000
36	0525082-360000	81	0525082-810000
39	0525082-390000	84	0525082-840000
42	0525082-420000	87	0525082-870000
45	0525082-450000	90	0525082-900000
48	0525082-480000	93	0525082-930000
51	0525082-510000	96	0525082-960000



2.54mm(0.10") Pitch  
Female Header Connector

0525091

Vertical, Through Hole

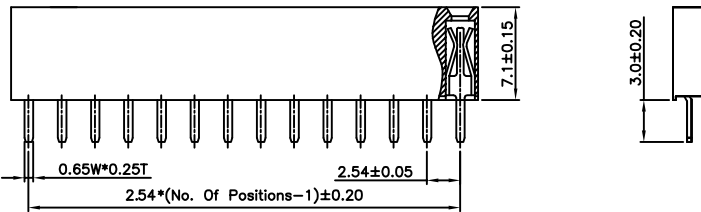
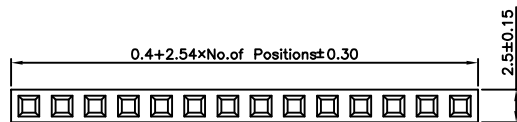

Specifications

Rating

Current Rating:3.0 Amp  
Voltage Rating:250V AC/DC  
Operating Temperature Range:-40~+105°C

Electrical

Contact resistance:20m Ohm Max  
Insulator resistance:1000M ohm min.  
Withstanding Voltage:500V AC/Minute

Material And Finish

Insulator:PBT UL94V-0 Color:Black  
Contact:Phosphor Bronze  
Plated:Gold Flash Over Nickel

No.of CKTS	Part No.	No.of CKTS	Part No.
		21	0525091-210002
02	0525091-020002	22	0525091-220002
03	0525091-030002	23	0525091-230002
04	0525091-040002	24	0525091-240002
05	0525091-050002	25	0525091-250002
06	0525091-060002	26	0525091-260002
07	0525091-070002	27	0525091-270002
08	0525091-080002	28	0525091-280002
09	0525091-090002	29	0525091-290002
10	0525091-100002	30	0525091-300002
11	0525091-110002	31	0525091-310002
12	0525091-120002	32	0525091-320002
13	0525091-130002	33	0525091-330002
14	0525091-140002	34	0525091-340002
15	0525091-150002	35	0525091-350002
16	0525091-160002	36	0525091-360002
17	0525091-170002	37	0525091-370002
18	0525091-180002	38	0525091-380002
19	0525091-190002	39	0525091-390002
20	0525091-200002	40	0525091-400002

2.54mm(0.10") Pitch  
Female Header Connector

0525098

Vertical, SMT

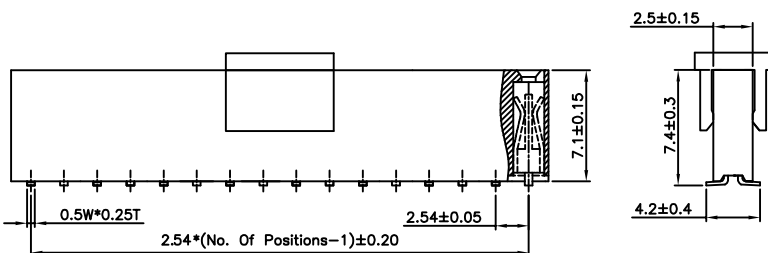
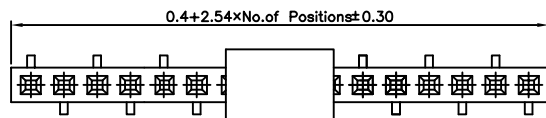

Specifications

Rating

Current Rating:3.0 Amp  
Voltage Rating:250V AC/DC  
Operating Temperature Range:-40~+105°C

Electrical

Contact resistance:20m Ohm Max  
Insulator resistance:1000M ohm min.  
Withstanding Voltage:500V AC/Minute

Material And Finish

Insulator:Nylon 6T UL94V-0 Color:Black  
Contact:Phosphor Bronze  
Plated:Gold Flash Over Nickel

No.of CKTS	Part No.	No.of CKTS	Part No.
		21	0525098-210105
02	0525098-020105	22	0525098-220105
03	0525098-030105	23	0525098-230105
04	0525098-040105	24	0525098-240105
05	0525098-050105	25	0525098-250105
06	0525098-060105	26	0525098-260105
07	0525098-070105	27	0525098-270105
08	0525098-080105	28	0525098-280105
09	0525098-090105	29	0525098-290105
10	0525098-100105	30	0525098-300105
11	0525098-110105	31	0525098-310105
12	0525098-120105	32	0525098-320105
13	0525098-130105	33	0525098-330105
14	0525098-140105	34	0525098-340105
15	0525098-150105	35	0525098-350105
16	0525098-160105	36	0525098-360105
17	0525098-170105	37	0525098-370105
18	0525098-180105	38	0525098-380105
19	0525098-190105	39	0525098-390105
20	0525098-200105	40	0525098-400105

2.54mm(0.10") Pitch  
Female Header Connector

**052509A**

Vertical, Through Hole

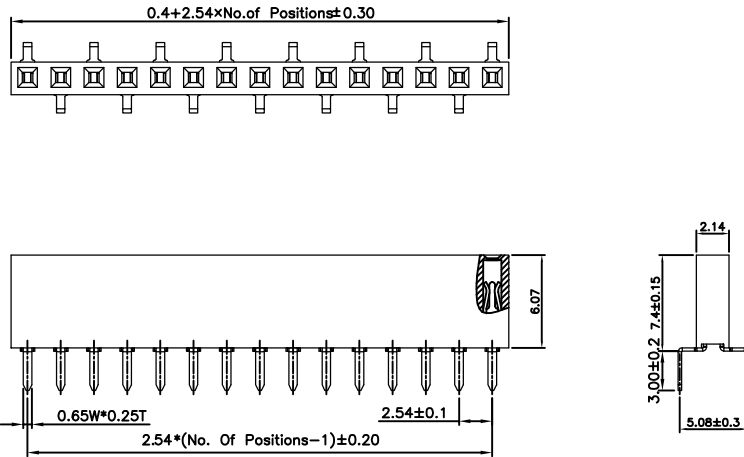

**Specifications**

**Rating**

Current Rating:3.0 Amp  
Voltage Rating:250V AC/DC  
Operating Temperature Range:-40~+105°C

**Electrical**

Contact resistance:20m Ohm Max  
Insulator resistance:1000M ohm min.  
Withstanding Voltage:500V AC/Minute

**Material And Finish**

Insulator:PBT UL94V-0 Color:Black  
Contact:Phosphor Bronze  
Plated:Gold Flash Over Nickel

No.of CKTS	Part No.	No.of CKTS	Part No.
		21	052509A-210001
02	052509A-020001	22	052509A-220001
03	052509A-030001	23	052509A-230001
04	052509A-040001	24	052509A-240001
05	052509A-050001	25	052509A-250001
06	052509A-060001	26	052509A-260001
07	052509A-070001	27	052509A-270001
08	052509A-080001	28	052509A-280001
09	052509A-090001	29	052509A-290001
10	052509A-100001	30	052509A-300001
11	052509A-110001	31	052509A-310001
12	052509A-120001	32	052509A-320001
13	052509A-130001	33	052509A-330001
14	052509A-140001	34	052509A-340001
15	052509A-150001	35	052509A-350001
16	052509A-160001	36	052509A-360001
17	052509A-170001	37	052509A-370001
18	052509A-180001	38	052509A-380001
19	052509A-190001	39	052509A-390001
20	052509A-200001	40	052509A-400001

2.54mm(0.10") Pitch  
Female Header Connector

**052509B**

Vertical, Through Hole

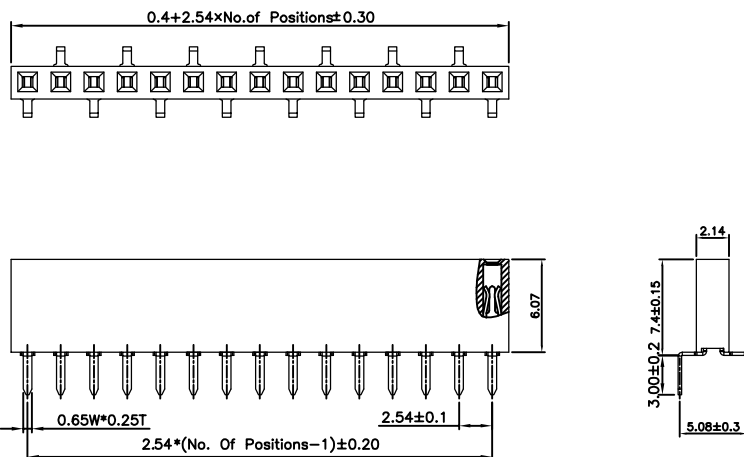

**Specifications**

**Rating**

Current Rating:3.0 Amp  
Voltage Rating:250V AC/DC  
Operating Temperature Range:-40~+105°C

**Electrical**

Contact resistance:20m Ohm Max  
Insulator resistance:1000M ohm min.  
Withstanding Voltage:500V AC/Minute

**Material And Finish**

Insulator:PBT UL94V-0 Color:Black  
Contact:Phosphor Bronze  
Plated:Gold Flash Over Nickel

No.of CKTS	Part No.	No.of CKTS	Part No.
		21	052509B-210001
02	052509B-020001	22	052509B-220001
03	052509B-030001	23	052509B-230001
04	052509B-040001	24	052509B-240001
05	052509B-050001	25	052509B-250001
06	052509B-060001	26	052509B-260001
07	052509B-070001	27	052509B-270001
08	052509B-080001	28	052509B-280001
09	052509B-090001	29	052509B-290001
10	052509B-100001	30	052509B-300001
11	052509B-110001	31	052509B-310001
12	052509B-120001	32	052509B-320001
13	052509B-130001	33	052509B-330001
14	052509B-140001	34	052509B-340001
15	052509B-150001	35	052509B-350001
16	052509B-160001	36	052509B-360001
17	052509B-170001	37	052509B-370001
18	052509B-180001	38	052509B-380001
19	052509B-190001	39	052509B-390001
20	052509B-200001	40	052509B-400001

2.54mm(0.10") Pitch  
Female Header Connector

0525101  
Vertical, Through Hole

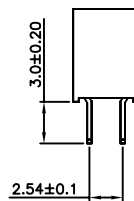
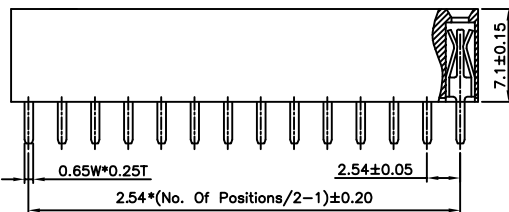
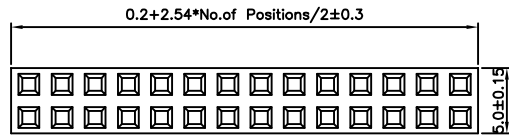

Specifications

Rating

Current Rating:3.0 Amp  
Voltage Rating:250V AC/DC  
Operating Temperature Range:-40°~+105°C

Electrical

Contact resistance:20m Ohm Max  
Insulator resistance:1000M ohm min.  
Withstanding Voltage:500V AC/Minute

Material And Finish

Insulator:PBT UL94V-0 Color:Black  
Contact:Phosphor Bronze  
Plated:Gold Flash Over Nickel

No.of CKTS	Part No.	No.of CKTS	Part No.
		42	0525101-420002
04	0525101-040002	44	0525101-440002
06	0525101-060002	46	0525101-460002
08	0525101-080002	48	0525101-480002
10	0525101-100002	50	0525101-500002
12	0525101-120002	52	0525101-520002
14	0525101-140002	54	0525101-540002
16	0525101-160002	56	0525101-560002
18	0525101-180002	58	0525101-580002
20	0525101-200002	60	0525101-600002
22	0525101-220002	62	0525101-620002
24	0525101-240002	64	0525101-640002
26	0525101-260002	66	0525101-660002
28	0525101-280002	68	0525101-680002
30	0525101-300002	70	0525101-700002
32	0525101-320002	72	0525101-720002
34	0525101-340002	74	0525101-740002
36	0525101-360002	76	0525101-760002
38	0525101-380002	78	0525101-780002
40	0525101-400002	80	0525101-800002

2.54mm(0.10") Pitch  
Female Header Connector

0525103  
Vertical, Through Hole

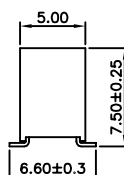
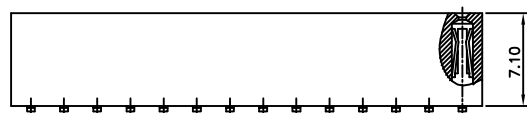
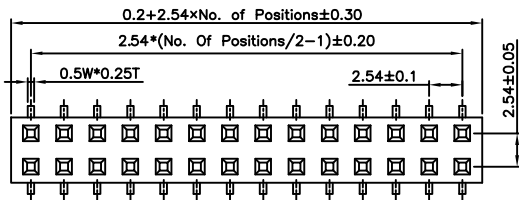

Specifications

Rating

Current Rating:3.0 Amp  
Voltage Rating:250V AC/DC  
Operating Temperature Range:-40°~+105°C

Electrical

Contact resistance:20m Ohm Max  
Insulator resistance:1000M ohm min.  
Withstanding Voltage:500V AC/Minute

Material And Finish

Insulator:Nylon 6T UL94V-0 Color:Black  
Contact:Phosphor Bronze  
Plated:Gold Flash Over Nickel

No.of CKTS	Part No.	No.of CKTS	Part No.
		42	0525103-420101
04	0525103-040101	44	0525103-440101
06	0525103-060101	46	0525103-460101
08	0525103-080101	48	0525103-480101
10	0525103-010110	50	0525103-500101
12	0525103-120101	52	0525103-520101
14	0525103-140101	54	0525103-540101
16	0525103-160101	56	0525103-560101
18	0525103-180101	58	0525103-580101
20	0525103-200101	60	0525103-600101
22	0525103-220101	62	0525103-620101
24	0525103-240101	64	0525103-640101
26	0525103-260101	66	0525103-660101
28	0525103-280101	68	0525103-680101
30	0525103-300101	70	0525103-700101
32	0525103-320101	72	0525103-720101
34	0525103-340101	74	0525103-740101
36	0525103-360101	76	0525103-760101
38	0525103-380101	78	0525103-780101
40	0525103-400101	80	0525103-800101

2.54mm(0.10") Pitch  
Female Header Connector

052510C1  
Vertical, Through Hole

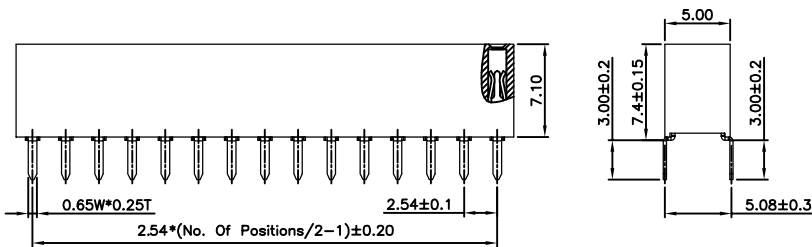
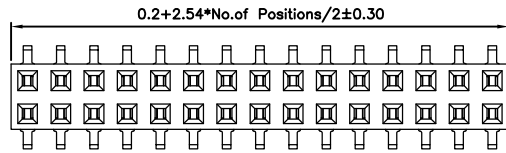
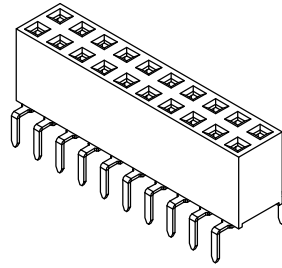

Specifications

Rating

Current Rating:3.0 Amp  
Voltage Rating:250V AC/DC  
Operating Temperature Range:-40~+105°C

Electrical

Contact resistance:20m Ohm Max  
Insulator resistance:1000M ohm min.  
Withstanding Voltage:500V AC/Minute

Material And Finish

Insulator:PBT UL94V-0 Color:Black  
Contact:Phosphor Bronze  
Plated:Gold Flash Over Nickel

No.of CKTS	Part No.	No.of CKTS	Part No.
04	052510C1-040001	42	052510C1-420001
06	052510C1-060001	44	052510C1-440001
08	052510C1-080001	46	052510C1-460001
10	052510C1-100001	48	052510C1-480001
12	052510C1-120001	50	052510C1-500001
14	052510C1-140001	52	052510C1-520001
16	052510C1-160001	54	052510C1-540001
18	052510C1-180001	56	052510C1-560001
20	052510C1-200001	58	052510C1-580001
22	052510C1-220001	60	052510C1-600001
24	052510C1-240001	62	052510C1-620001
26	052510C1-260001	64	052510C1-640001
28	052510C1-280001	66	052510C1-660001
30	052510C1-300001	68	052510C1-680001
32	052510C1-320001	70	052510C1-700001
34	052510C1-340001	72	052510C1-720001
36	052510C1-360001	74	052510C1-740001
38	052510C1-380001	76	052510C1-760001
40	052510C1-400001	78	052510C1-780001
		80	052510C1-800001

2.54mm(0.10") Pitch  
Female Header Connector

052510C2  
Vertical, Through Hole

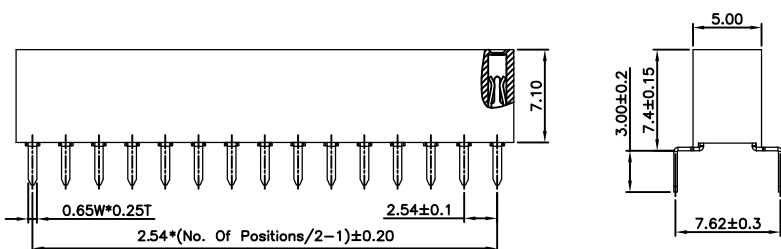
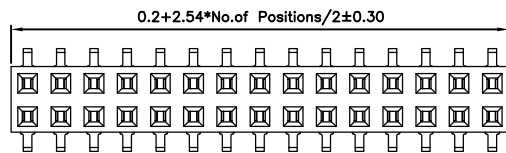
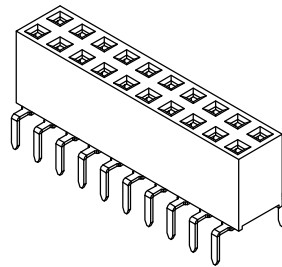

Specifications

Rating

Current Rating:3.0 Amp  
Voltage Rating:250V AC/DC  
Operating Temperature Range:-40~+105°C

Electrical

Contact resistance:20m Ohm Max  
Insulator resistance:1000M ohm min.  
Withstanding Voltage:500V AC/Minute

Material And Finish

Insulator:PBT UL94V-0 Color:Black  
Contact:Phosphor Bronze  
Plated:Gold Flash Over Nickel

No.of CKTS	Part No.	No.of CKTS	Part No.
04	052510C2-040001	42	052510C2-420001
06	052510C2-060001	44	052510C2-440001
08	052510C2-080001	46	052510C2-460001
10	052510C2-100001	48	052510C2-480001
12	052510C2-120001	50	052510C2-500001
14	052510C2-140001	52	052510C2-520001
16	052510C2-160001	54	052510C2-540001
18	052510C2-180001	56	052510C2-560001
20	052510C2-200001	58	052510C2-580001
22	052510C2-220001	60	052510C2-600001
24	052510C2-240001	62	052510C2-620001
26	052510C2-260001	64	052510C2-640001
28	052510C2-280001	66	052510C2-660001
30	052510C2-300001	68	052510C2-680001
32	052510C2-320001	70	052510C2-700001
34	052510C2-340001	72	052510C2-720001
36	052510C2-360001	74	052510C2-740001
38	052510C2-380001	76	052510C2-760001
40	052510C2-400001	78	052510C2-780001
		80	052510C2-800001

2.54mm(0.10") Pitch  
Female Header Connector

0525121  
Vertical, Through Hole

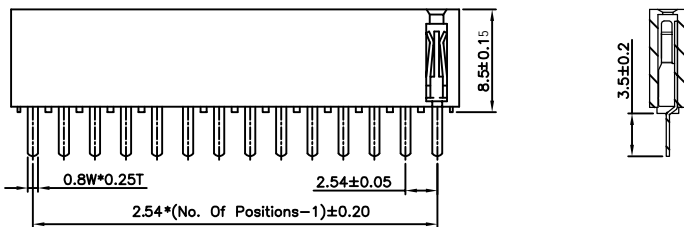
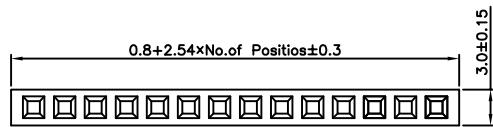

Specifications

Rating

Current Rating:3.0 Amp  
Voltage Rating:250V AC/DC  
Operating Temperature Range:-40°~+105°C

Electrical

Contact resistance:20m Ohm Max  
Insulator resistance:1000M ohm min.  
Withstanding Voltage:500V AC/Minute

Material And Finish

Insulator:PBT UL94V-0 Color:Black  
Contact:Phosphor Bronze  
Plated:Gold Flash Over Nickel

No.of CKTS	Part No.	No.of CKTS	Part No.
		21	0525121-210002
02	0525121-020002	22	0525121-220002
03	0525121-030002	23	0525121-230002
04	0525121-040002	24	0525121-240002
05	0525121-050002	25	0525121-250002
06	0525121-060002	26	0525121-260002
07	0525121-070002	27	0525121-270002
08	0525121-080002	28	0525121-280002
09	0525121-090002	29	0525121-290002
10	0525121-100002	30	0525121-300002
11	0525121-110002	31	0525121-310002
12	0525121-120002	32	0525121-320002
13	0525121-130002	33	0525121-330002
14	0525121-140002	34	0525121-340002
15	0525121-150002	35	0525121-350002
16	0525121-160002	36	0525121-360002
17	0525121-170002	37	0525121-370002
18	0525121-180002	38	0525121-380002
19	0525121-190002	39	0525121-390002
20	0525121-200002	40	0525121-400002

2.54mm(0.10") Pitch  
Female Header Connector

0525131  
Vertical, Through Hole

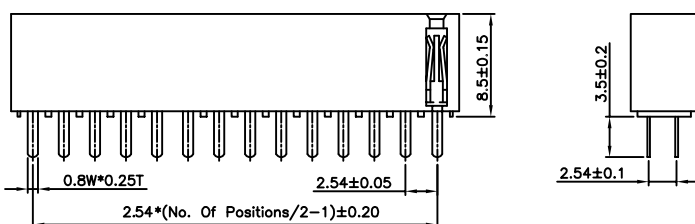
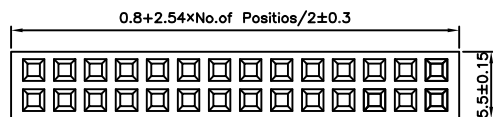

Specifications

Rating

Current Rating:3.0 Amp  
Voltage Rating:250V AC/DC  
Operating Temperature Range:-40°~+105°C

Electrical

Contact resistance:20m Ohm Max  
Insulator resistance:1000M ohm min.  
Withstanding Voltage:500V AC/Minute

Material And Finish

Insulator:PBT UL94V-0 Color:Black  
Contact:Phosphor Bronze  
Plated:Gold Flash Over Nickel

No.of CKTS	Part No.	No.of CKTS	Part No.
		42	0525131-420002
04	0525131-040002	44	0525131-440002
06	0525131-060002	46	0525131-460002
08	0525131-080002	48	0525131-480002
10	0525131-100002	50	0525131-500002
12	0525131-120002	52	0525131-520002
14	0525131-140002	54	0525131-540002
16	0525131-160002	56	0525131-560002
18	0525131-180002	58	0525131-580002
20	0525131-200002	60	0525131-600002
22	0525131-220002	62	0525131-620002
24	0525131-240002	64	0525131-640002
26	0525131-260002	66	0525131-660002
28	0525131-280002	68	0525131-680002
30	0525131-300002	70	0525131-700002
32	0525131-320002	72	0525131-720002
34	0525131-340002	74	0525131-740002
36	0525131-360002	76	0525131-760002
38	0525131-380002	78	0525131-780002
40	0525131-400002	80	0525131-800002

2.54mm(0.10") Pitch  
Female Header Connector

0525141  
Vertical, Through Hole

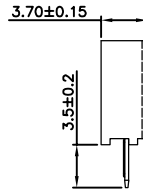
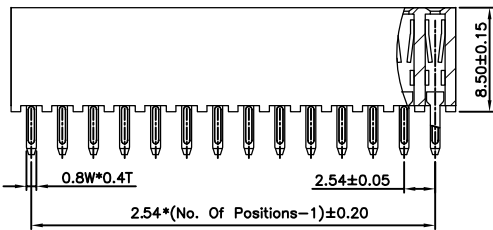
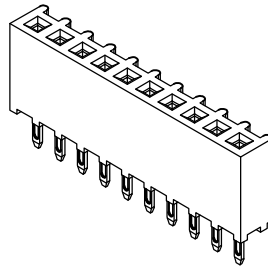
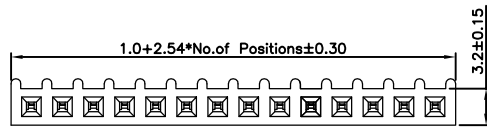

Specifications

Rating

Current Rating:3.0 Amp  
Voltage Rating:250V AC/DC  
Operating Temperature Range:-40°~+105°C

Electrical

Contact resistance:20m Ohm Max  
Insulator resistance:1000M ohm min.  
Withstanding Voltage:500V AC/Minute

Material And Finish

Insulator:PBT UL94V-0 Color:Black  
Contact:Phosphor Bronze  
Plated:Gold Flash Over Nickel

No.of CKTS	Part No.	No.of CKTS	Part No.
		21	0525141-210002
02	0525141-020002	22	0525141-220002
03	0525141-030002	23	0525141-230002
04	0525141-040002	24	0525141-240002
05	0525141-050002	25	0525141-250002
06	0525141-060002	26	0525141-260002
07	0525141-070002	27	0525141-270002
08	0525141-080002	28	0525141-280002
09	0525141-090002	29	0525141-290002
10	0525141-100002	30	0525141-300002
11	0525141-110002	31	0525141-310002
12	0525141-120002	32	0525141-320002
13	0525141-130002	33	0525141-330002
14	0525141-140002	34	0525141-340002
15	0525141-150002	35	0525141-350002
16	0525141-160002	36	0525141-360002
17	0525141-170002	37	0525141-370002
18	0525141-180002	38	0525141-380002
19	0525141-190002	39	0525141-390002
20	0525141-200002	40	0525141-400002

2.54mm(0.10") Pitch  
Female Header Connector

0525151  
Vertical, Through Hole

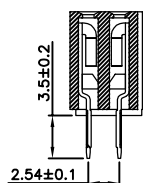
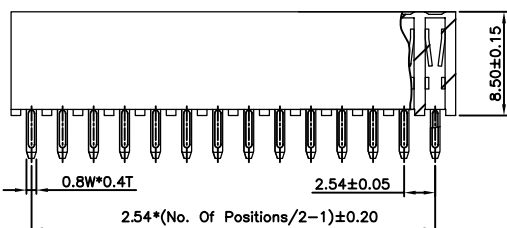
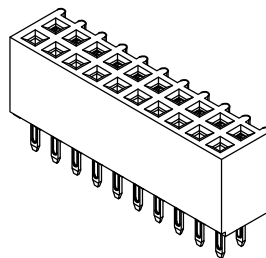
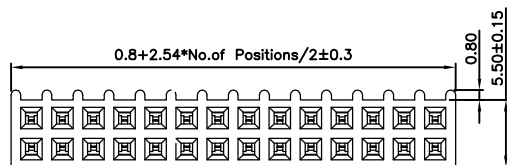

Specifications

Rating

Current Rating:3.0 Amp  
Voltage Rating:250V AC/DC  
Operating Temperature Range:-40°~+105°C

Electrical

Contact resistance:20m Ohm Max  
Insulator resistance:1000M ohm min.  
Withstanding Voltage:500V AC/Minute

Material And Finish

Insulator:PBT UL94V-0 Color:Black  
Contact:Phosphor Bronze  
Plated:Gold Flash Over Nickel

No.of CKTS	Part No.	No.of CKTS	Part No.
		21	0525151-210002
02	0525151-020002	22	0525151-220002
03	0525151-030002	23	0525151-230002
04	0525151-040002	24	0525151-240002
05	0525151-050002	25	0525151-250002
06	0525151-060002	26	0525151-260002
07	0525151-070002	27	0525151-270002
08	0525151-080002	28	0525151-280002
09	0525151-090002	29	0525151-290002
10	0525151-100002	30	0525151-300002
11	0525151-110002	31	0525151-310002
12	0525151-120002	32	0525151-320002
13	0525151-130002	33	0525151-330002
14	0525151-140002	34	0525151-340002
15	0525151-150002	35	0525151-350002
16	0525151-160002	36	0525151-360002
17	0525151-170002	37	0525151-370002
18	0525151-180002	38	0525151-380002
19	0525151-190002	39	0525151-390002
20	0525151-200002	40	0525151-400002

2.54mm(0.10") Pitch  
Female Header Connector

052516C1  
Vertical, Through Hole

Specifications

Rating

Current Rating:3.0 Amp  
Voltage Rating:250V AC/DC  
Operating Temperature Range:-40~+105°C

Electrical

Contact resistance:20m Ohm Max  
Insulator resistance:1000M ohm min.  
Withstanding Voltage:500V AC/Minute

Material And Finish

Insulator:PBT UL94V-0 Color:Black  
Contact:Phosphor Bronze  
Plated:Gold Flash Over Nickel

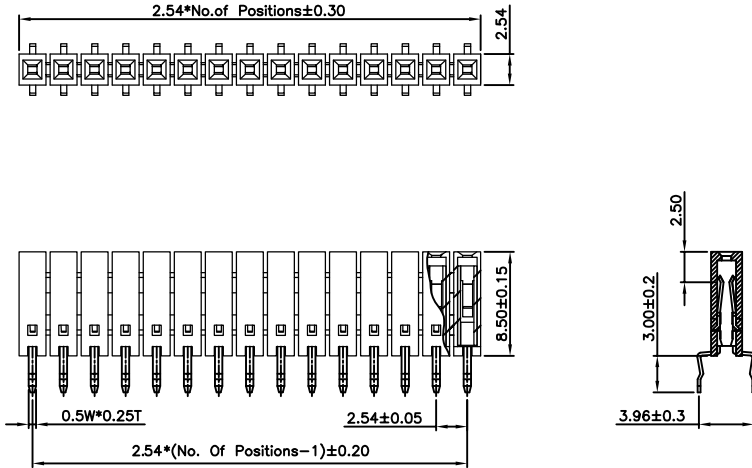

No. of CKTS	Part No.	No. of CKTS	Part No.
		21	052516C1-210001
02	052516C1-020001	22	052516C1-220001
03	052516C1-030001	23	052516C1-230001
04	052516C1-040001	24	052516C1-240001
05	052516C1-050001	25	052516C1-250001
06	052516C1-060001	26	052516C1-260001
07	052516C1-070001	27	052516C1-270001
08	052516C1-080001	28	052516C1-280001
09	052516C1-090001	29	052516C1-290001
10	052516C1-100001	30	052516C1-300001
11	052516C1-110001	31	052516C1-310001
12	052516C1-120001	32	052516C1-320001
13	052516C1-130001	33	052516C1-330001
14	052516C1-140001	34	052516C1-340001
15	052516C1-150001	35	052516C1-350001
16	052516C1-160001	36	052516C1-360001
17	052516C1-170001	37	052516C1-370001
18	052516C1-180001	38	052516C1-380001
19	052516C1-190001	39	052516C1-390001
20	052516C1-200001	40	052516C1-400001

2.54mm(0.10") Pitch  
Female Header Connector

052516C2  
Vertical, Through Hole

Specifications

Rating

Current Rating:3.0 Amp  
Voltage Rating:250V AC/DC  
Operating Temperature Range:-40~+105°C

Electrical

Contact resistance:20m Ohm Max  
Insulator resistance:1000M ohm min.  
Withstanding Voltage:500V AC/Minute

Material And Finish

Insulator:PBT UL94V-0 Color:Black  
Contact:Phosphor Bronze  
Plated:Gold Flash Over Nickel

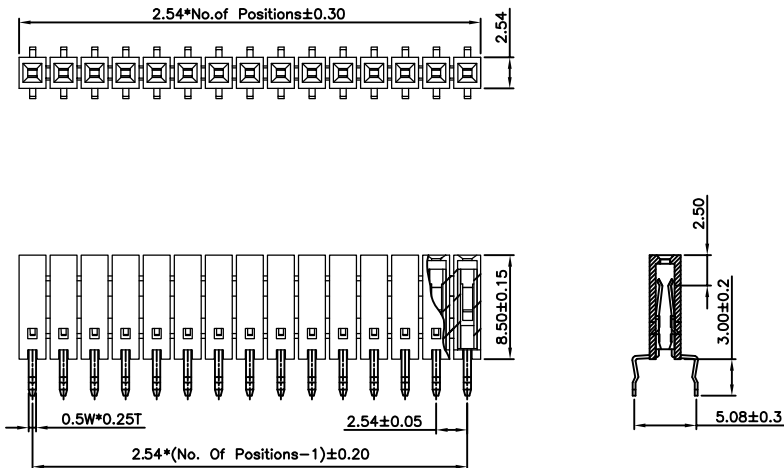

No. of CKTS	Part No.	No. of CKTS	Part No.
		21	052516C2-210001
02	052516C2-020001	22	052516C2-220001
03	052516C2-030001	23	052516C2-230001
04	052516C2-040001	24	052516C2-240001
05	052516C2-050001	25	052516C2-250001
06	052516C2-060001	26	052516C2-260001
07	052516C2-070001	27	052516C2-270001
08	052516C2-080001	28	052516C2-280001
09	052516C2-090001	29	052516C2-290001
10	052516C2-100001	30	052516C2-300001
11	052516C2-110001	31	052516C2-310001
12	052516C2-120001	32	052516C2-320001
13	052516C2-130001	33	052516C2-330001
14	052516C2-140001	34	052516C2-340001
15	052516C2-150001	35	052516C2-350001
16	052516C2-160001	36	052516C2-360001
17	052516C2-170001	37	052516C2-370001
18	052516C2-180001	38	052516C2-380001
19	052516C2-190001	39	052516C2-390001
20	052516C2-200001	40	052516C2-400001

2.54mm(0.10") Pitch  
Female Header Connector

052517C1

Vertical, Through Hole

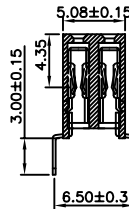
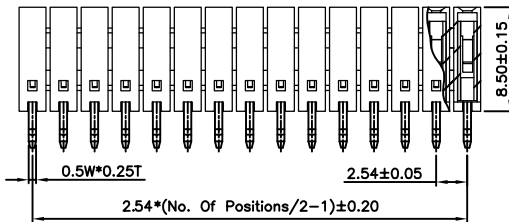
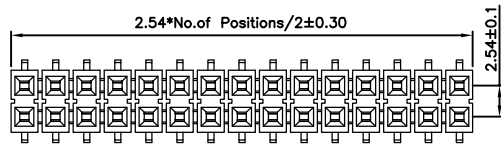
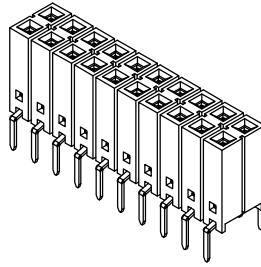

Specifications

Rating

Current Rating:3.0 Amp  
Voltage Rating:250V AC/DC  
Operating Temperature Range:-40~+105°C

Electrical

Contact resistance:20m Ohm Max  
Insulator resistance:1000M ohm min.  
Withstanding Voltage:500V AC/Minute

Material And Finish

Insulator:PBT UL94V-0 Color:Black  
Contact:Phosphor Bronze  
Plated:Gold Flash Over Nickel

No.of CKTS	Part No.	No.of CKTS	Part No.
04	052517C1-040001	42	052517C1-420001
06	052517C1-060001	44	052517C1-440001
08	052517C1-080001	46	052517C1-460001
10	052517C1-100001	48	052517C1-480001
12	052517C1-120001	50	052517C1-500001
14	052517C1-140001	52	052517C1-520001
16	052517C1-160001	54	052517C1-540001
18	052517C1-180001	56	052517C1-560001
20	052517C1-200001	58	052517C1-580001
22	052517C1-220001	60	052517C1-600001
24	052517C1-240001	62	052517C1-620001
26	052517C1-260001	64	052517C1-640001
28	052517C1-280001	66	052517C1-660001
30	052517C1-300001	68	052517C1-680001
32	052517C1-320001	70	052517C1-700001
34	052517C1-340001	72	052517C1-720001
36	052517C1-360001	74	052517C1-740001
38	052517C1-380001	76	052517C1-760001
40	052517C1-400001	78	052517C1-780001
		80	052517C1-800001

2.54mm(0.10") Pitch  
Female Header Connector

052517C2

Vertical, Through Hole

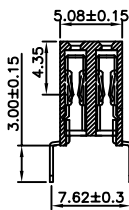
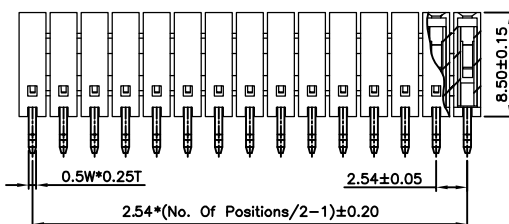
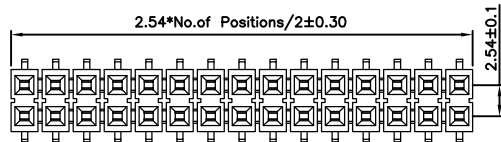
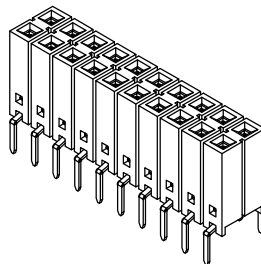

Specifications

Rating

Current Rating:3.0 Amp  
Voltage Rating:250V AC/DC  
Operating Temperature Range:-40~+105°C

Electrical

Contact resistance:20m Ohm Max  
Insulator resistance:1000M ohm min.  
Withstanding Voltage:500V AC/Minute

Material And Finish

Insulator:PBT UL94V-0 Color:Black  
Contact:Phosphor Bronze  
Plated:Gold Flash Over Nickel

No.of CKTS	Part No.	No.of CKTS	Part No.
04	052517C2-040001	42	052517C2-420001
06	052517C2-060001	44	052517C2-440001
08	052517C2-080001	46	052517C2-460001
10	052517C2-100001	48	052517C2-480001
12	052517C2-120001	50	052517C2-500001
14	052517C2-140001	52	052517C2-520001
16	052517C2-160001	54	052517C2-540001
18	052517C2-180001	56	052517C2-560001
20	052517C2-200001	58	052517C2-580001
22	052517C2-220001	60	052517C2-600001
24	052517C2-240001	62	052517C2-620001
26	052517C2-260001	64	052517C2-640001
28	052517C2-280001	66	052517C2-660001
30	052517C2-300001	68	052517C2-680001
32	052517C2-320001	70	052517C2-700001
34	052517C2-340001	72	052517C2-720001
36	052517C2-360001	74	052517C2-740001
38	052517C2-380001	76	052517C2-760001
40	052517C2-400001	78	052517C2-780001
		80	052517C2-800001



2.54mm(0.10") Pitch  
Female Header Connector

0525181

Vertical, Through Hole

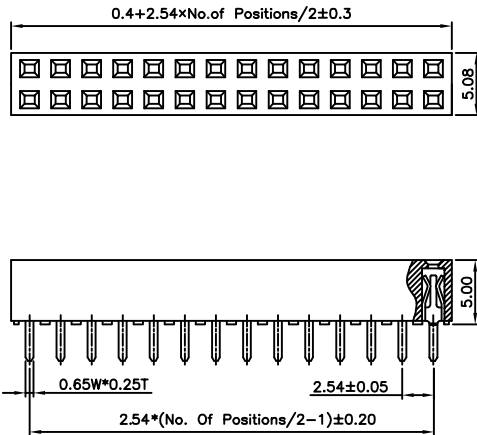

Specifications

Rating

Current Rating:3.0 Amp  
Voltage Rating:250V AC/DC  
Operating Temperature Range:-40°~+105°C

Electrical

Contact resistance:20m Ohm Max  
Insulator resistance:1000M ohm min.  
Withstanding Voltage:500V AC/Minute

Material And Finish

Insulator:PBT UL94V-0 Color:Black  
Contact:Phosphor Bronze  
Plated:Gold Flash Over Nickel

No.of CKTS	Part No.	No.of CKTS	Part No.
		42	0525181-420002
04	0525181-040002	44	0525181-440002
06	0525181-060002	46	0525181-460002
08	0525181-080002	48	0525181-480002
10	0525181-100002	50	0525181-500002
12	0525181-120002	52	0525181-520002
14	0525181-140002	54	0525181-540002
16	0525181-160002	56	0525181-560002
18	0525181-180002	58	0525181-580002
20	0525181-200002	60	0525181-600002
22	0525181-220002	62	0525181-620002
24	0525181-240002	64	0525181-640002
26	0525181-260002	66	0525181-660002
28	0525181-280002	68	0525181-680002
30	0525181-300002	70	0525181-700002
32	0525181-320002	72	0525181-720002
34	0525181-340002	74	0525181-740002
36	0525181-360002	76	0525181-760002
38	0525181-380002	78	0525181-780002
40	0525181-400002	80	0525181-800002

2.54mm(0.10") Pitch  
Female Header Connector

0525186

Vertical, SMT

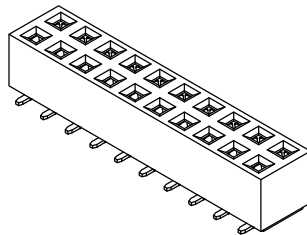
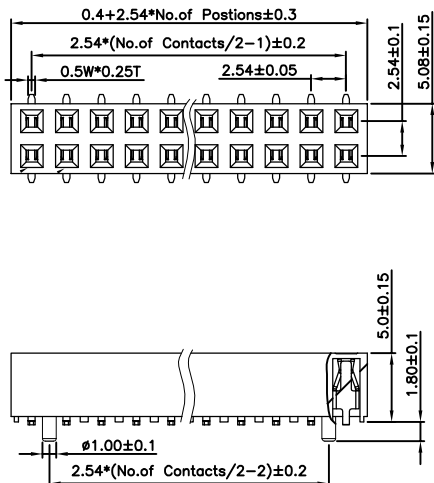

Specifications

Rating

Current Rating:3.0 Amp  
Voltage Rating:250V AC/DC  
Operating Temperature Range:-40°~+105°C

Electrical

Contact resistance:20m Ohm Max  
Insulator resistance:1000M ohm min.  
Withstanding Voltage:500V AC/Minute

Material And Finish

Insulator:Nylon 6T UL94V-0 Color:Black  
Contact:Phosphor Bronze  
Plated:Gold Flash Over Nickel

No.of CKTS	Part No.	No.of CKTS	Part No.
		42	0525186-420101
04	0525186-040101	44	0525186-440101
06	0525186-060101	46	0525186-460101
08	0525186-080101	48	0525186-480101
10	0525186-100101	50	0525186-500101
12	0525186-120101	52	0525186-520101
14	0525186-140101	54	0525186-540101
16	0525186-160101	56	0525186-560101
18	0525186-180101	58	0525186-580101
20	0525186-200101	60	0525186-600101
22	0525186-220101	62	0525186-620101
24	0525186-240101	64	0525186-640101
26	0525186-260101	66	0525186-660101
28	0525186-280101	68	0525186-680101
30	0525186-300101	70	0525186-700101
32	0525186-320101	72	0525186-720101
34	0525186-340101	74	0525186-740101
36	0525186-360101	76	0525186-760101
38	0525186-380101	78	0525186-780101
40	0525186-400101	80	0525186-800101

2.54mm(0.10") Pitch  
Female Header Connector

052518C1  
Vertical, Through Hole

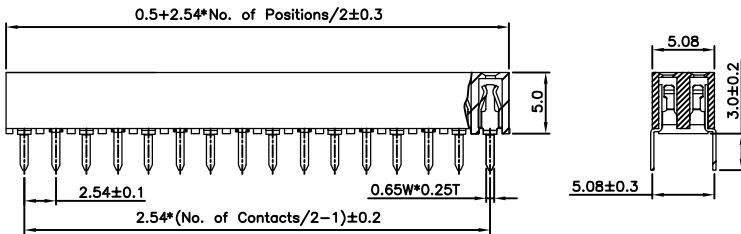
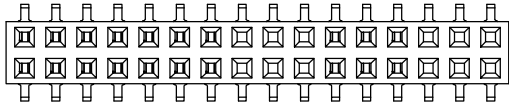
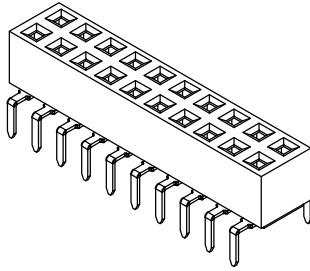

**Specifications**

**Rating**

Current Rating:3.0 Amp  
Voltage Rating:250V AC/DC  
Operating Temperature Range:-40~+105°C

**Electrical**

Contact resistance:20m Ohm Max  
Insulator resistance:1000M ohm min.  
Withstanding Voltage:500V AC/Minute

**Material And Finish**

Insulator:PBT UL94V-0 Color:Black  
Contact:Phosphor Bronze  
Plated:Gold Flash Over Nickel

No.of CKTS	Part No.	No.of CKTS	Part No.
04	052518C1-040001	42	052518C1-420001
06	052518C1-060001	44	052518C1-440001
08	052518C1-080001	46	052518C1-460001
10	052518C1-100001	48	052518C1-480001
12	052518C1-120001	50	052518C1-500001
14	052518C1-140001	52	052518C1-520001
16	052518C1-160001	54	052518C1-540001
18	052518C1-180001	56	052518C1-560001
20	052518C1-200001	58	052518C1-580001
22	052518C1-220001	60	052518C1-600001
24	052518C1-240001	62	052518C1-620001
26	052518C1-260001	64	052518C1-640001
28	052518C1-280001	66	052518C1-660001
30	052518C1-300001	68	052518C1-680001
32	052518C1-320001	70	052518C1-700001
34	052518C1-340001	72	052518C1-720001
36	052518C1-360001	74	052518C1-740001
38	052518C1-380001	76	052518C1-760001
40	052518C1-400001	78	052518C1-780001
		80	052518C1-800001

2.54mm(0.10") Pitch  
Female Header Connector

052518C2  
Vertical, Through Hole

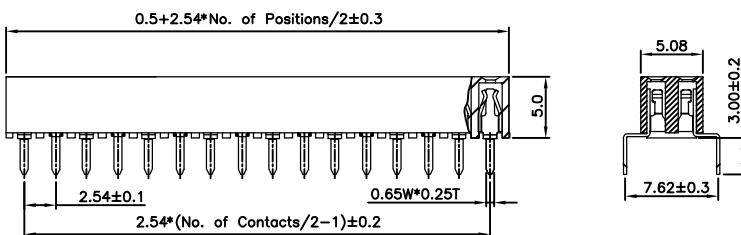
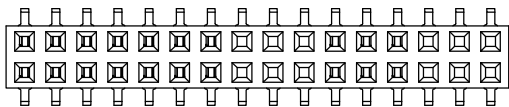
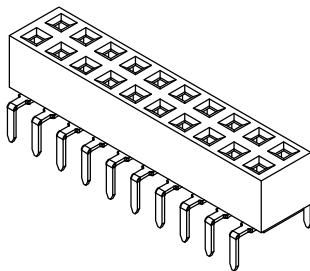

**Specifications**

**Rating**

Current Rating:3.0 Amp  
Voltage Rating:250V AC/DC  
Operating Temperature Range:-40~+105°C

**Electrical**

Contact resistance:20m Ohm Max  
Insulator resistance:1000M ohm min.  
Withstanding Voltage:500V AC/Minute

**Material And Finish**

Insulator:PBT UL94V-0 Color:Black  
Contact:Phosphor Bronze  
Plated:Gold Flash Over Nickel

No.of CKTS	Part No.	No.of CKTS	Part No.
04	052518C2-040001	42	052518C2-420001
06	052518C2-060001	44	052518C2-440001
08	052518C2-080001	46	052518C2-460001
10	052518C2-100001	48	052518C2-480001
12	052518C2-120001	50	052518C2-500001
14	052518C2-140001	52	052518C2-520001
16	052518C2-160001	54	052518C2-540001
18	052518C2-180001	56	052518C2-560001
20	052518C2-200001	58	052518C2-580001
22	052518C2-220001	60	052518C2-600001
24	052518C2-240001	62	052518C2-620001
26	052518C2-260001	64	052518C2-640001
28	052518C2-280001	66	052518C2-660001
30	052518C2-300001	68	052518C2-680001
32	052518C2-320001	70	052518C2-700001
34	052518C2-340001	72	052518C2-720001
36	052518C2-360001	74	052518C2-740001
38	052518C2-380001	76	052518C2-760001
40	052518C2-400001	78	052518C2-780001
		80	052518C2-800001

2.54mm(0.10") Pitch  
Female Header Connector

0525191  
Vertical, Through Hole

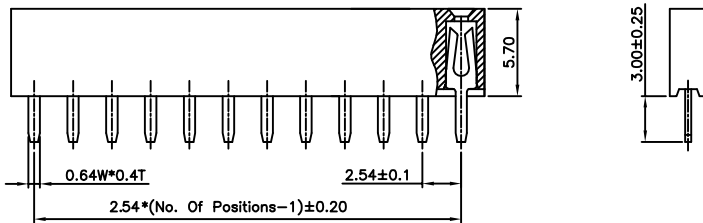
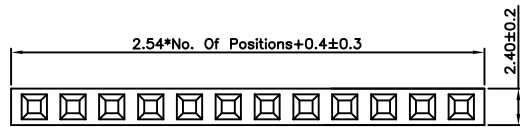

Specifications

Rating

Current Rating:3.0 Amp  
Voltage Rating:250V AC/DC  
Operating Temperature Range:-40~+105°C

Electrical

Contact resistance:20m Ohm Max  
Insulator resistance:1000M ohm min.  
Withstanding Voltage:500V AC/Minute

Material And Finish

Insulator:PBT UL94V-0 Color:Black  
Contact:Phosphor Bronze  
Plated:Gold Flash Over Nickel

No.of CKTS	Part No.	No.of CKTS	Part No.
		21	0525191-210002
02	0525191-020002	22	0525191-220002
03	0525191-030002	23	0525191-230002
04	0525191-040002	24	0525191-240002
05	0525191-050002	25	0525191-250002
06	0525191-060002	26	0525191-260002
07	0525191-070002	27	0525191-270002
08	0525191-080002	28	0525191-280002
09	0525191-090002	29	0525191-290002
10	0525191-100002	30	0525191-300002
11	0525191-110002	31	0525191-310002
12	0525191-120002	32	0525191-320002
13	0525191-130002	33	0525191-330002
14	0525191-140002	34	0525191-340002
15	0525191-150002	35	0525191-350002
16	0525191-160002	36	0525191-360002
17	0525191-170002	37	0525191-370002
18	0525191-180002	38	0525191-380002
19	0525191-190002	39	0525191-390002
20	0525191-200002	40	0525191-400002

2.54mm(0.10") Pitch  
Female Header Connector

0525192  
Right Angle, Through Hole

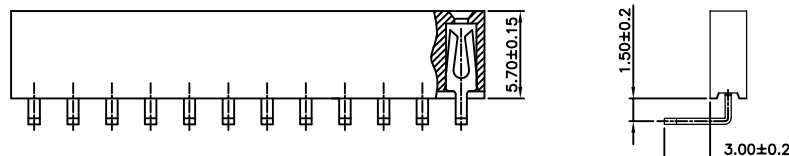
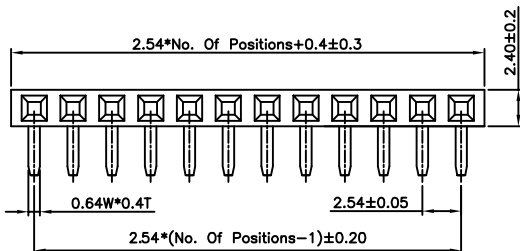

Specifications

Rating

Current Rating:3.0 Amp  
Voltage Rating:250V AC/DC  
Operating Temperature Range:-40~+105°C

Electrical

Contact resistance:20m Ohm Max  
Insulator resistance:1000M ohm min.  
Withstanding Voltage:500V AC/Minute

Material And Finish

Insulator:PBT UL94V-0 Color:Black  
Contact:Phosphor Bronze  
Plated:Gold Flash Over Nickel

No.of CKTS	Part No.	No.of CKTS	Part No.
		21	0525192-210002
02	0525192-020002	22	0525192-220002
03	0525192-030002	23	0525192-230002
04	0525192-040002	24	0525192-240002
05	0525192-050002	25	0525192-250002
06	0525192-060002	26	0525192-260002
07	0525192-070002	27	0525192-270002
08	0525192-080002	28	0525192-280002
09	0525192-090002	29	0525192-290002
10	0525192-100002	30	0525192-300002
11	0525192-110002	31	0525192-310002
12	0525192-120002	32	0525192-320002
13	0525192-130002	33	0525192-330002
14	0525192-140002	34	0525192-340002
15	0525192-150002	35	0525192-350002
16	0525192-160002	36	0525192-360002
17	0525192-170002	37	0525192-370002
18	0525192-180002	38	0525192-380002
19	0525192-190002	39	0525192-390002
20	0525192-200002	40	0525192-400002

2.54mm(0.10") Pitch  
Female Header Connector

0525201

Vertical, Through Hole

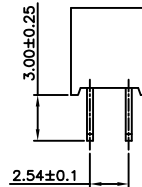
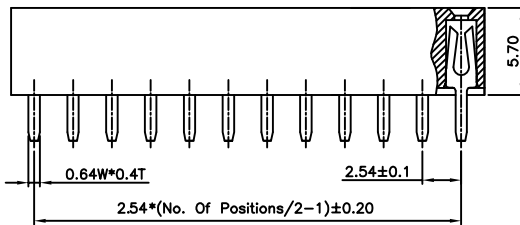
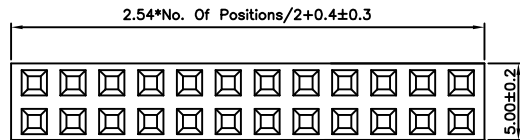

Specifications

Rating

Current Rating:3.0 Amp  
Voltage Rating:250V AC/DC  
Operating Temperature Range:-40~+105°C

Electrical

Contact resistance:20m Ohm Max  
Insulator resistance:1000M ohm min.  
Withstanding Voltage:500V AC/Minute

Material And Finish

Insulator:PBT UL94V-0 Color:Black  
Contact:Phosphor Bronze  
Plated:Gold Flash Over Nickel

No.of CKTS	Part No.	No.of CKTS	Part No.
		42	0525201-420002
04	0525201-040002	44	0525201-440002
06	0525201-060002	46	0525201-460002
08	0525201-080002	48	0525201-480002
10	0525201-100002	50	0525201-500002
12	0525201-120002	52	0525201-520002
14	0525201-140002	54	0525201-540002
16	0525201-160002	56	0525201-560002
18	0525201-180002	58	0525201-580002
20	0525201-200002	60	0525201-600002
22	0525201-220002	62	0525201-620002
24	0525201-240002	64	0525201-640002
26	0525201-260002	66	0525201-660002
28	0525201-280002	68	0525201-680002
30	0525201-300002	70	0525201-700002
32	0525201-320002	72	0525201-720002
34	0525201-340002	74	0525201-740002
36	0525201-360002	76	0525201-760002
38	0525201-380002	78	0525201-780002
40	0525201-400002	80	0525201-800002

2.54mm(0.10") Pitch  
Female Header Connector

0525202

Right Angle, Through Hole

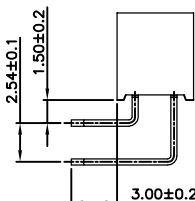
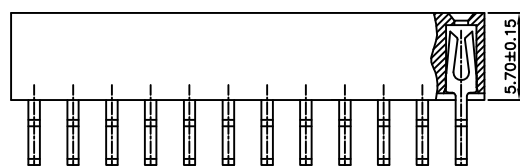
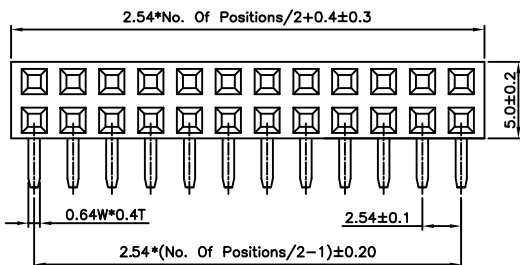

Specifications

Rating

Current Rating:3.0 Amp  
Voltage Rating:250V AC/DC  
Operating Temperature Range:-40~+105°C

Electrical

Contact resistance:20m Ohm Max  
Insulator resistance:1000M ohm min.  
Withstanding Voltage:500V AC/Minute

Material And Finish

Insulator:PBT UL94V-0 Color:Black  
Contact:Phosphor Bronze  
Plated:Gold Flash Over Nickel

No.of CKTS	Part No.	No.of CKTS	Part No.
		42	0525202-420002
04	0525202-040002	44	0525202-440002
06	0525202-060002	46	0525202-460002
08	0525202-080002	48	0525202-480002
10	0525202-100002	50	0525202-500002
12	0525202-120002	52	0525202-520002
14	0525202-140002	54	0525202-540002
16	0525202-160002	56	0525202-560002
18	0525202-180002	58	0525202-580002
20	0525202-200002	60	0525202-600002
22	0525202-220002	62	0525202-620002
24	0525202-240002	64	0525202-640002
26	0525202-260002	66	0525202-660002
28	0525202-280002	68	0525202-680002
30	0525202-300002	70	0525202-700002
32	0525202-320002	72	0525202-720002
34	0525202-340002	74	0525202-740002
36	0525202-360002	76	0525202-760002
38	0525202-380002	78	0525202-780002
40	0525202-400002	80	0525202-800002

2.54mm(0.10") Pitch  
Female Header Connector

0525111  
Vertical, Through Hole

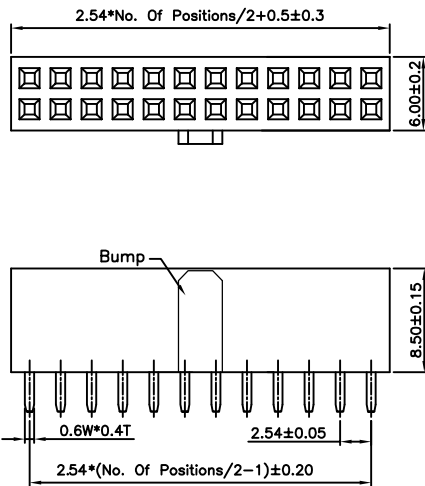

Specifications

Rating

Current Rating:3.0 Amp  
Voltage Rating:250V AC/DC  
Operating Temperature Range:-40°~+105°C

Electrical

Contact resistance:20m Ohm Max  
Insulator resistance:1000M ohm min.  
Withstanding Voltage:500V AC/Minute

Material And Finish

Insulator:PBT UL94V-0 Color:Black  
Contact:Phosphor Bronze  
Plated:Gold Flash Over Nickel

No.of CKTS	Part No.	No.of CKTS	Part No.
04	0525111-040002	42	0525111-420002
06	0525111-060002	44	0525111-440002
08	0525111-080002	46	0525111-460002
10	0525111-100002	48	0525111-480002
12	0525111-120002	50	0525111-500002
14	0525111-140002	52	0525111-520002
16	0525111-160002	54	0525111-540002
18	0525111-180002	56	0525111-560002
20	0525111-200002	58	0525111-580002
22	0525111-220002	60	0525111-600002
24	0525111-240002	62	0525111-620002
26	0525111-260002	64	0525111-640002
28	0525111-280002	66	0525111-660002
30	0525111-300002	68	0525111-680002
32	0525111-320002	70	0525111-700002
34	0525111-340002	72	0525111-720002
36	0525111-360002	74	0525111-740002
38	0525111-380002	76	0525111-760002
40	0525111-400002	78	0525111-780002
		80	0525111-800002

2.54mm(0.10") Pitch  
Female Header Connector

0525112  
Right Angle, Through Hole

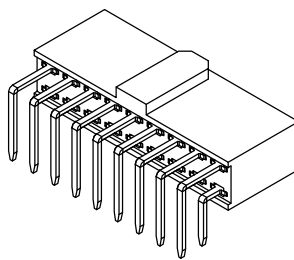
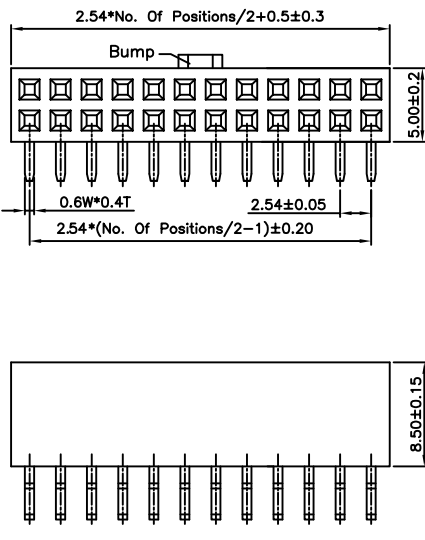

Specifications

Rating

Current Rating:3.0 Amp  
Voltage Rating:250V AC/DC  
Operating Temperature Range:-40°~+105°C

Electrical

Contact resistance:20m Ohm Max  
Insulator resistance:1000M ohm min.  
Withstanding Voltage:500V AC/Minute

Material And Finish

Insulator:PBT UL94V-0 Color:Black  
Contact:Phosphor Bronze  
Plated:Gold Flash Over Nickel

No.of CKTS	Part No.	No.of CKTS	Part No.
04	0525112-040002	42	0525112-420002
06	0525112-060002	44	0525112-440002
08	0525112-080002	46	0525112-460002
10	0525112-100002	48	0525112-480002
12	0525112-120002	50	0525112-500002
14	0525112-140002	52	0525112-520002
16	0525112-160002	54	0525112-540002
18	0525112-180002	56	0525112-560002
20	0525112-200002	58	0525112-580002
22	0525112-220002	60	0525112-600002
24	0525112-240002	62	0525112-620002
26	0525112-260002	64	0525112-640002
28	0525112-280002	66	0525112-660002
30	0525112-300002	68	0525112-680002
32	0525112-320002	70	0525112-700002
34	0525112-340002	72	0525112-720002
36	0525112-360002	74	0525112-740002
38	0525112-380002	76	0525112-760002
40	0525112-400002	78	0525112-780002
		80	0525112-800002

2.54mm(0.10") Pitch  
Female Header Connector

0525113  
Vertical, SMT

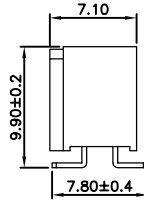
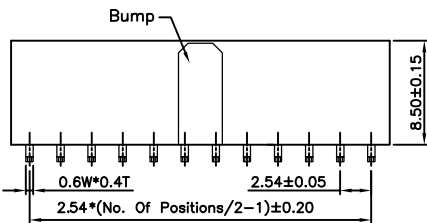
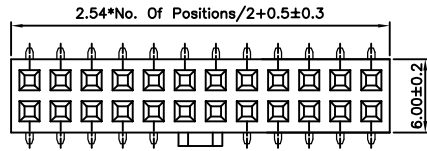

Specifications

Rating

Current Rating:3.0 Amp  
Voltage Rating:250V AC/DC  
Operating Temperature Range:-40°~+105°C

Electrical

Contact resistance:20m Ohm Max  
Insulator resistance:1000M ohm min.  
Withstanding Voltage:500V AC/Minute

Material And Finish

Insulator:Nylon 6T UL94V-0 Color:Black  
Contact:Phosphor Bronze  
Plated:Gold Flash Over Nickel

No.of CKTS	Part No.	No.of CKTS	Part No.
04	0525113-040101	42	0525113-420101
06	0525113-060101	44	0525113-440101
08	0525113-080101	46	0525113-460101
10	0525113-100101	48	0525113-480101
12	0525113-120101	50	0525113-500101
14	0525113-140101	52	0525113-520101
16	0525113-160101	54	0525113-540101
18	0525113-180101	56	0525113-560101
20	0525113-200101	58	0525113-580101
22	0525113-220101	60	0525113-600101
24	0525113-240101	62	0525113-620101
26	0525113-260101	64	0525113-640101
28	0525113-280101	66	0525113-660101
30	0525113-300101	68	0525113-680101
32	0525113-320101	70	0525113-700101
34	0525113-340101	72	0525113-720101
36	0525113-360101	74	0525113-740101
38	0525113-380101	76	0525113-760101
40	0525113-400101	78	0525113-780101
		80	0525113-800101

2.54mm(0.10") Pitch  
Female Header Connector

052521C2  
Vertical, Through Hole

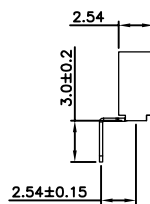
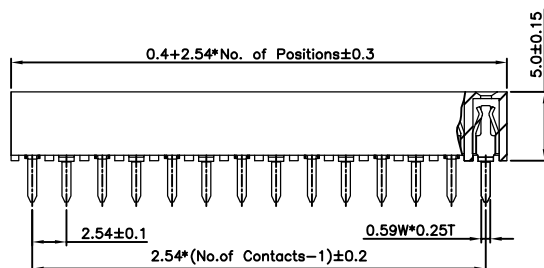
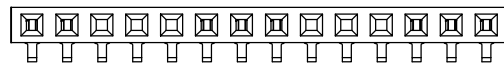

Specifications

Rating

Current Rating:3.0 Amp  
Voltage Rating:250V AC/DC  
Operating Temperature Range:-40°~+105°C

Electrical

Contact resistance:20m Ohm Max  
Insulator resistance:1000M ohm min.  
Withstanding Voltage:500V AC/Minute

Material And Finish

Insulator:PBT UL94V-0 Color:Black  
Contact:Phosphor Bronze  
Plated:Gold Flash Over Nickel

No.of CKTS	Part No.	No.of CKTS	Part No.
02	052521C2-020001	21	052521C2-210001
03	052521C2-030001	22	052521C2-220001
04	052521C2-040001	23	052521C2-230001
05	052521C2-050001	24	052521C2-240001
06	052521C2-060001	25	052521C2-250001
07	052521C2-070001	26	052521C2-260001
08	052521C2-080001	27	052521C2-270001
09	052521C2-090001	28	052521C2-280001
10	052521C2-100001	29	052521C2-290001
11	052521C2-110001	30	052521C2-300001
12	052521C2-120001	31	052521C2-310001
13	052521C2-130001	32	052521C2-320001
14	052521C2-140001	33	052521C2-330001
15	052521C2-150001	34	052521C2-340001
16	052521C2-160001	35	052521C2-350001
17	052521C2-170001	36	052521C2-360001
18	052521C2-180001	37	052521C2-370001
19	052521C2-190001	38	052521C2-380001
20	052521C2-200001	39	052521C2-390001
		40	052521C2-400001

2.54mm(0.10") Pitch  
Female Header Connector

0525211

Vertical, Through Hole

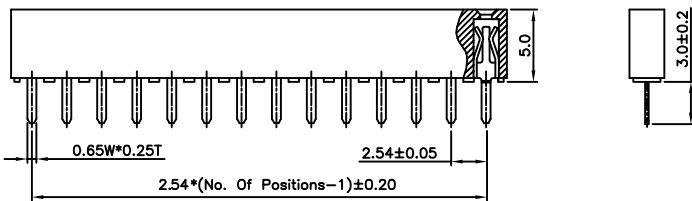
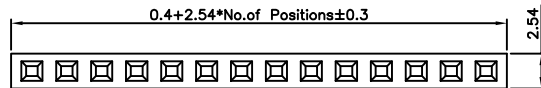

Specifications

Rating

Current Rating:3.0 Amp  
Voltage Rating:250V AC/DC  
Operating Temperature Range:-40°~+105°C

Electrical

Contact resistance:20m Ohm Max  
Insulator resistance:1000M ohm min.  
Withstanding Voltage:500V AC/Minute

Material And Finish

Insulator:PBT UL94V-0 Color:Black  
Contact:Phosphor Bronze  
Plated:Gold Flash Over Nickel

No.of CKTS	Part No.	No.of CKTS	Part No.
		21	0525211-210002
02	0525211-020002	22	0525211-220002
03	0525211-030002	23	0525211-230002
04	0525211-040002	24	0525211-240002
05	0525211-050002	25	0525211-250002
06	0525211-060002	26	0525211-260002
07	0525211-070002	27	0525211-270002
08	0525211-080002	28	0525211-280002
09	0525211-090002	29	0525211-290002
10	0525211-100002	30	0525211-300002
11	0525211-110002	31	0525211-310002
12	0525211-120002	32	0525211-320002
13	0525211-130002	33	0525211-330002
14	0525211-140002	34	0525211-340002
15	0525211-150002	35	0525211-350002
16	0525211-160002	36	0525211-360002
17	0525211-170002	37	0525211-370002
18	0525211-180002	38	0525211-380002
19	0525211-190002	39	0525211-390002
20	0525211-200002	40	0525211-400002

2.54mm(0.10") Pitch  
Female Header Connector

0525212

Right Angle, Through Hole

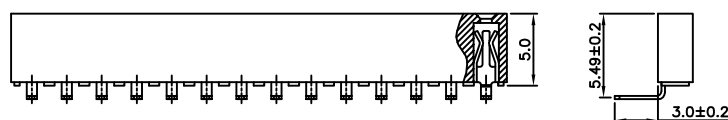
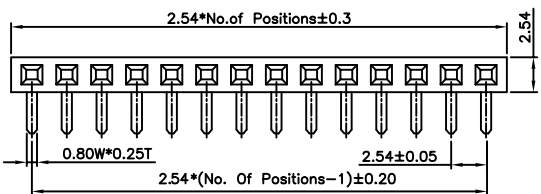

Specifications

Rating

Current Rating:3.0 Amp  
Voltage Rating:250V AC/DC  
Operating Temperature Range:-40°~+105°C

Electrical

Contact resistance:20m Ohm Max  
Insulator resistance:1000M ohm min.  
Withstanding Voltage:500V AC/Minute

Material And Finish

Insulator:PBT UL94V-0 Color:Black  
Contact:Phosphor Bronze  
Plated:Gold Flash Over Nickel

No.of CKTS	Part No.	No.of CKTS	Part No.
		21	0525212-210002
02	0525212-020002	22	0525212-220002
03	0525212-030002	23	0525212-230002
04	0525212-040002	24	0525212-240002
05	0525212-050002	25	0525212-250002
06	0525212-060002	26	0525212-260002
07	0525212-070002	27	0525212-270002
08	0525212-080002	28	0525212-280002
09	0525212-090002	29	0525212-290002
10	0525212-100002	30	0525212-300002
11	0525212-110002	31	0525212-310002
12	0525212-120002	32	0525212-320002
13	0525212-130002	33	0525212-330002
14	0525212-140002	34	0525212-340002
15	0525212-150002	35	0525212-350002
16	0525212-160002	36	0525212-360002
17	0525212-170002	37	0525212-370002
18	0525212-180002	38	0525212-380002
19	0525212-190002	39	0525212-390002
20	0525212-200002	40	0525212-400002

2.54mm(0.10") Pitch  
Female Header Connector

**052521A1**

Vertical, Through Hole

**Specifications**

**Rating**

Current Rating:3.0 Amp  
Voltage Rating:250V AC/DC  
Operating Temperature Range:-40~+105°C

**Electrical**

Contact resistance:20m Ohm Max  
Insulator resistance:1000M ohm min.  
Withstanding Voltage:500V AC/Minute

**Material And Finish**

Insulator:PBT UL94V-0 Color:Black  
Contact:Phosphor Bronze  
Plated:Gold Flash Over Nickel

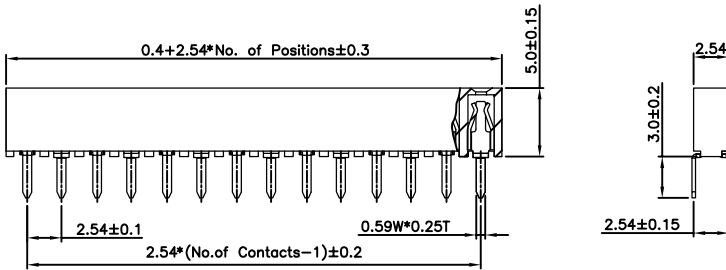
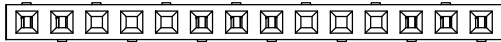

No.of CKTS	Part No.	No.of CKTS	Part No.
		21	052521A1-210001
02	052521A1-020001	22	052521A1-220001
03	052521A1-030001	23	052521A1-230001
04	052521A1-040001	24	052521A1-240001
05	052521A1-050001	25	052521A1-250001
06	052521A1-060001	26	052521A1-260001
07	052521A1-070001	27	052521A1-270001
08	052521A1-080001	28	052521A1-280001
09	052521A1-090001	29	052521A1-290001
10	052521A1-100001	30	052521A1-300001
11	052521A1-110001	31	052521A1-310001
12	052521A1-120001	32	052521A1-320001
13	052521A1-130001	33	052521A1-330001
14	052521A1-140001	34	052521A1-340001
15	052521A1-150001	35	052521A1-350001
16	052521A1-160001	36	052521A1-360001
17	052521A1-170001	37	052521A1-370001
18	052521A1-180001	38	052521A1-380001
19	052521A1-190001	39	052521A1-390001
20	052521A1-200001	40	052521A1-400001

2.54mm(0.10") Pitch  
Female Header Connector

**052521A2**

Vertical, Through Hole

**Specifications**

**Rating**

Current Rating:3.0 Amp  
Voltage Rating:250V AC/DC  
Operating Temperature Range:-40~+105°C

**Electrical**

Contact resistance:20m Ohm Max  
Insulator resistance:1000M ohm min.  
Withstanding Voltage:500V AC/Minute

**Material And Finish**

Insulator:PBT UL94V-0 Color:Black  
Contact:Phosphor Bronze  
Plated:Gold Flash Over Nickel

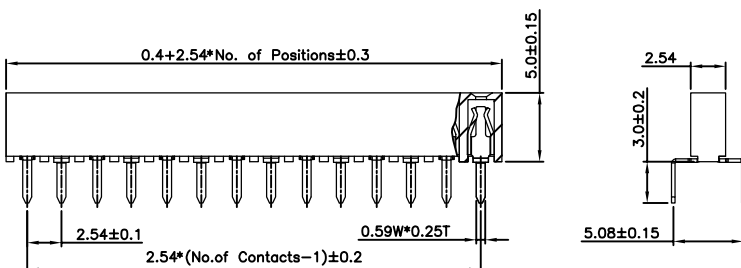

No.of CKTS	Part No.	No.of CKTS	Part No.
		21	052521A2-210001
02	052521A2-020001	22	052521A2-220001
03	052521A2-030001	23	052521A2-230001
04	052521A2-040001	24	052521A2-240001
05	052521A2-050001	25	052521A2-250001
06	052521A2-060001	26	052521A2-260001
07	052521A2-070001	27	052521A2-270001
08	052521A2-080001	28	052521A2-280001
09	052521A2-090001	29	052521A2-290001
10	052521A2-100001	30	052521A2-300001
11	052521A2-110001	31	052521A2-310001
12	052521A2-120001	32	052521A2-320001
13	052521A2-130001	33	052521A2-330001
14	052521A2-140001	34	052521A2-340001
15	052521A2-150001	35	052521A2-350001
16	052521A2-160001	36	052521A2-360001
17	052521A2-170001	37	052521A2-370001
18	052521A2-180001	38	052521A2-380001
19	052521A2-190001	39	052521A2-390001
20	052521A2-200001	40	052521A2-400001



2.54mm(0.10") Pitch  
Female Header Connector

0525221  
Vertical, Through Hole

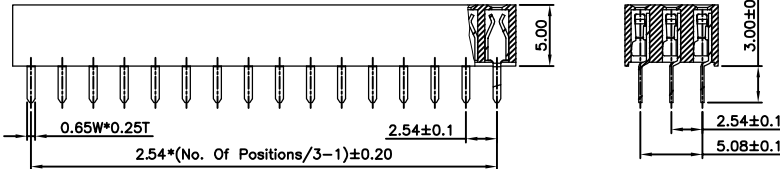
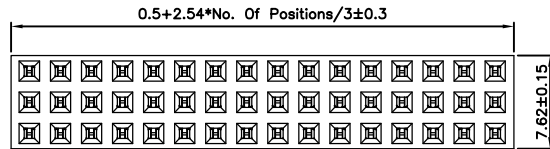
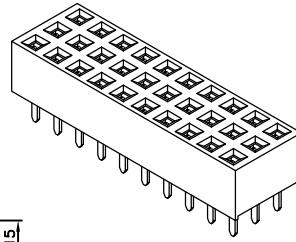

Specifications

Rating

Current Rating:3.0 Amp  
Voltage Rating:250V AC/DC  
Operating Temperature Range:-40~+105°C

Electrical

Contact resistance:20m Ohm Max  
Insulator resistance:1000M ohm min.  
Withstanding Voltage:500V AC/Minute

Material And Finish

Insulator:PBT UL94V-0 Color:Black  
Contact:Phosphor Bronze  
Plated:Gold Flash Over Nickel

No.of CKTS	Part No.	No.of CKTS	Part No.
09	0525221-090002	54	0525221-540002
12	0525221-120002	57	0525221-570002
15	0525221-150002	60	0525221-600002
18	0525221-180002	63	0525221-630002
21	0525221-210002	66	0525221-660002
24	0525221-240002	69	0525221-690002
27	0525221-270002	72	0525221-720002
30	0525221-300002	75	0525221-750002
33	0525221-330002	78	0525221-780002
36	0525221-360002	81	0525221-810002
39	0525221-390002	84	0525221-840002
42	0525221-420002	87	0525221-870002
45	0525221-450002	90	0525221-900002
48	0525221-480002	93	0525221-930002
51	0525221-510002	96	0525221-960002

2.54mm(0.10") Pitch  
Female Header Connector

0525231  
Vertical, Through Hole

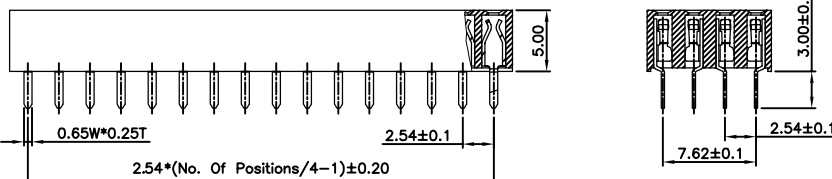
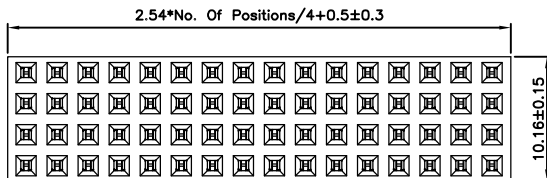
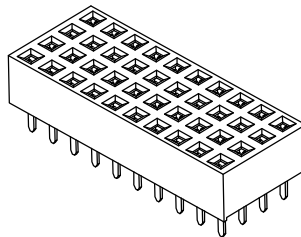

Specifications

Rating

Current Rating:3.0 Amp  
Voltage Rating:250V AC/DC  
Operating Temperature Range:-40~+105°C

Electrical

Contact resistance:20m Ohm Max  
Insulator resistance:1000M ohm min.  
Withstanding Voltage:500V AC/Minute

Material And Finish

Insulator:PBT UL94V-0 Color:Black  
Contact:Phosphor Bronze  
Plated:Gold Flash Over Nickel

No.of CKTS	Part No.	No.of CKTS	Part No.
16	0525231-160002	68	0525231-680002
20	0525231-200002	72	0525231-720002
24	0525231-240002	76	0525231-760002
28	0525231-280002	80	0525231-800002
32	0525231-320002	84	0525231-840002
36	0525231-360002	88	0525231-880002
40	0525231-400002	92	0525231-920002
44	0525231-440002	96	0525231-960002
48	0525231-480002	100	0525231-100002
52	0525231-520002	104	0525231-1040002
56	0525231-560002	108	0525231-1080002
60	0525231-600002	112	0525231-1120002
64	0525231-640002	116	0525231-1160002
		120	0525231-1200002

2.54mm(0.10") Pitch  
Female Header Connector

0525241  
Vertical, Through Hole

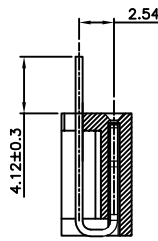
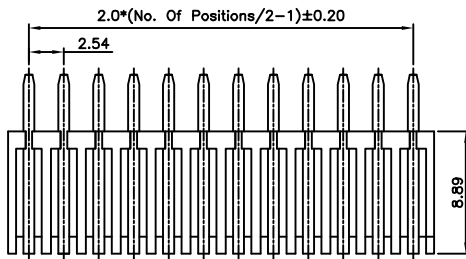
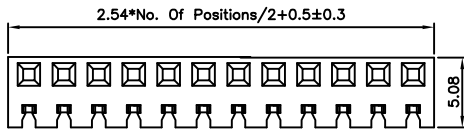

Specifications

Rating

Current Rating:3.0 Amp  
Voltage Rating:250V AC/DC  
Operating Temperature Range:-40°~+105°C

Electrical

Contact resistance:20m Ohm Max  
Insulator resistance:1000M ohm min.  
Withstanding Voltage:500V AC/Minute

Material And Finish

Insulator:PBT UL94V-0 Color:Black  
Contact:Phosphor Bronze  
Plated:Gold Flash Over Nickel

No.of CKTS	Part No.	No.of CKTS	Part No.
		21	0525241-210002
02	0525241-020002	22	0525241-220002
03	0525241-030002	23	0525241-230002
04	0525241-040002	24	0525241-240002
05	0525241-050002	25	0525241-250002
06	0525241-060002	26	0525241-260002
07	0525241-070002	27	0525241-270002
08	0525241-080002	28	0525241-280002
09	0525241-090002	29	0525241-290002
10	0525241-100002	30	0525241-300002
11	0525241-110002	31	0525241-310002
12	0525241-120002	32	0525241-320002
13	0525241-130002	33	0525241-330002
14	0525241-140002	34	0525241-340002
15	0525241-150002	35	0525241-350002
16	0525241-160002	36	0525241-360002
17	0525241-170002	37	0525241-370002
18	0525241-180002	38	0525241-380002
19	0525241-190002	39	0525241-390002
20	0525241-200002	40	0525241-400002

2.54mm(0.10") Pitch  
Female Header Connector

0525251  
Vertical, Through Hole

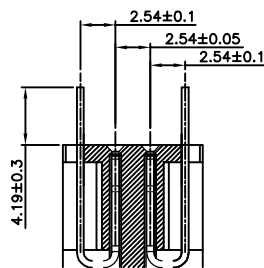
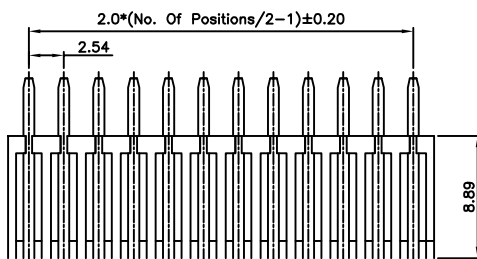
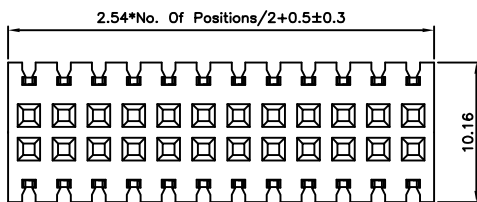

Specifications

Rating

Current Rating:3.0 Amp  
Voltage Rating:250V AC/DC  
Operating Temperature Range:-40°~+105°C

Electrical

Contact resistance:20m Ohm Max  
Insulator resistance:1000M ohm min.  
Withstanding Voltage:500V AC/Minute

Material And Finish

Insulator:PBT UL94V-0 Color:Black  
Contact:Phosphor Bronze  
Plated:Gold Flash Over Nickel

No.of CKTS	Part No.	No.of CKTS	Part No.
		42	0525251-420002
04	0525251-040002	44	0525251-440002
06	0525251-060002	46	0525251-460002
08	0525251-080002	48	0525251-480002
10	0525251-100002	50	0525251-500002
12	0525251-120002	52	0525251-520002
14	0525251-140002	54	0525251-540002
16	0525251-160002	56	0525251-560002
18	0525251-180002	58	0525251-580002
20	0525251-200002	60	0525251-600002
22	0525251-220002	62	0525251-620002
24	0525251-240002	64	0525251-640002
26	0525251-260002	66	0525251-660002
28	0525251-280002	68	0525251-680002
30	0525251-300002	70	0525251-700002
32	0525251-320002	72	0525251-720002
34	0525251-340002	74	0525251-740002
36	0525251-360002	76	0525251-760002
38	0525251-380002	78	0525251-780002
40	0525251-400002	80	0525251-800002